

La cabane

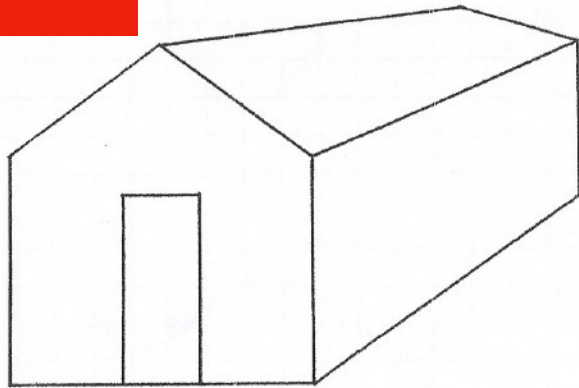

La cabane sans le toit

On voit la base des murs.

Les nombres sont exprimés en centimètres.

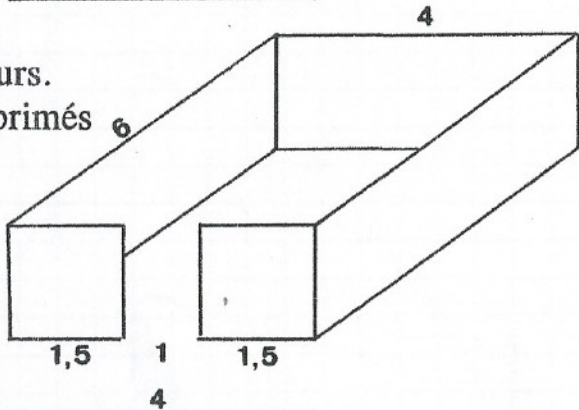

Plan de la cabane

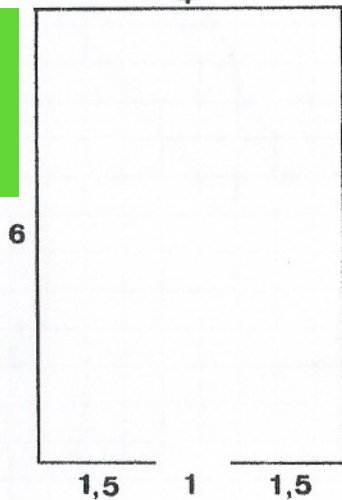

la maison avec garage

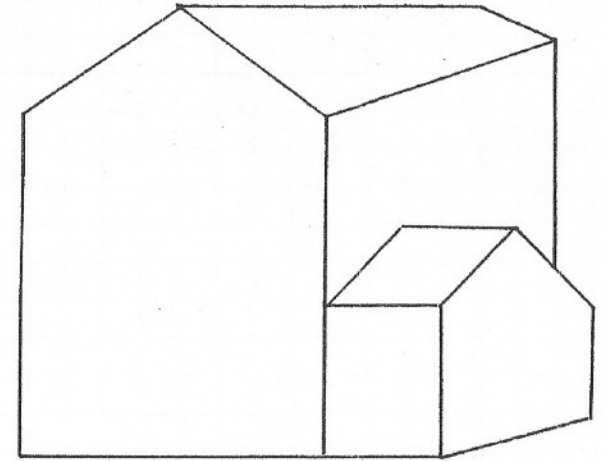

La maison et le garage sans le toit

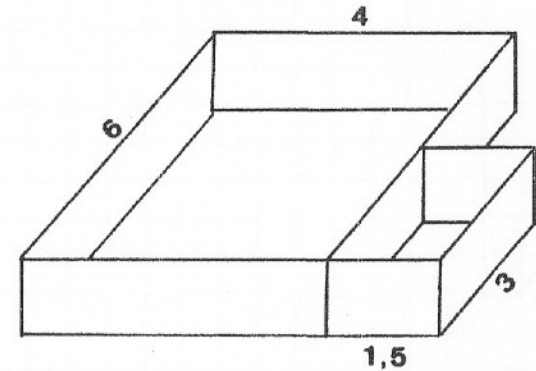

Plan de la maison avec garage

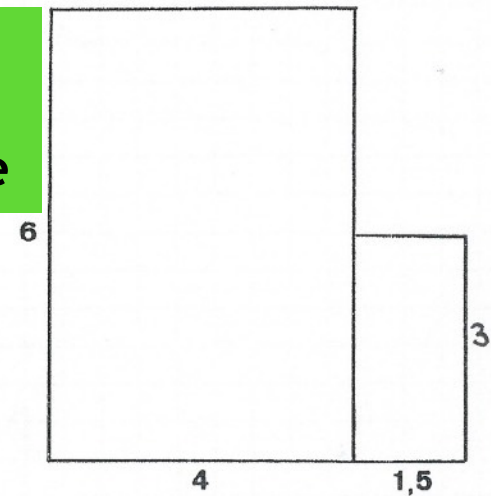

Dessine le plan de l'école à 2 classes

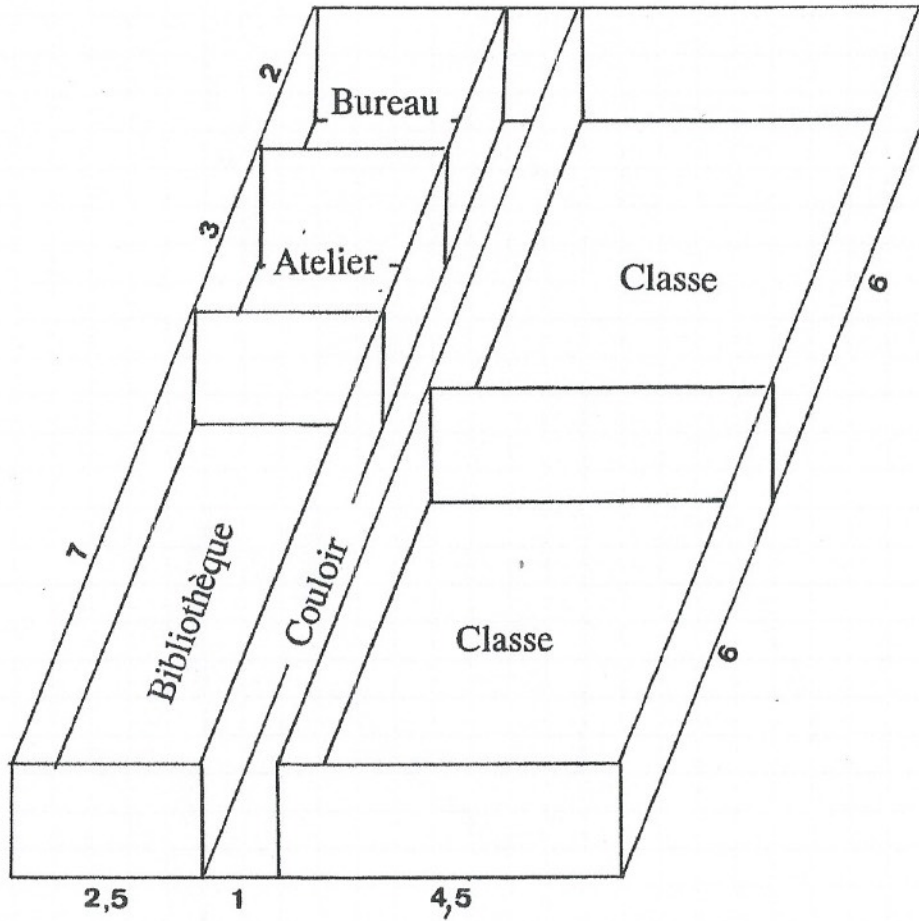

Dessine le plan de la ferme

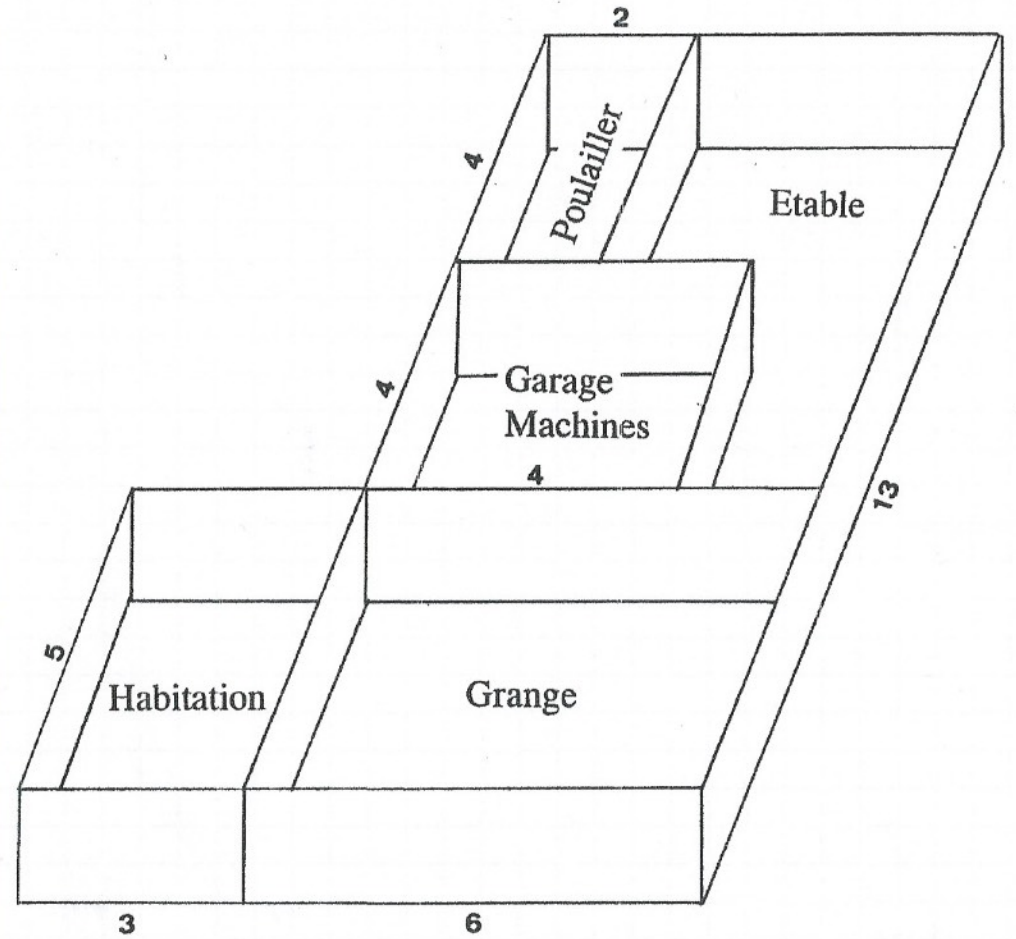

Corrigé

Plan de l'école à 2 classes

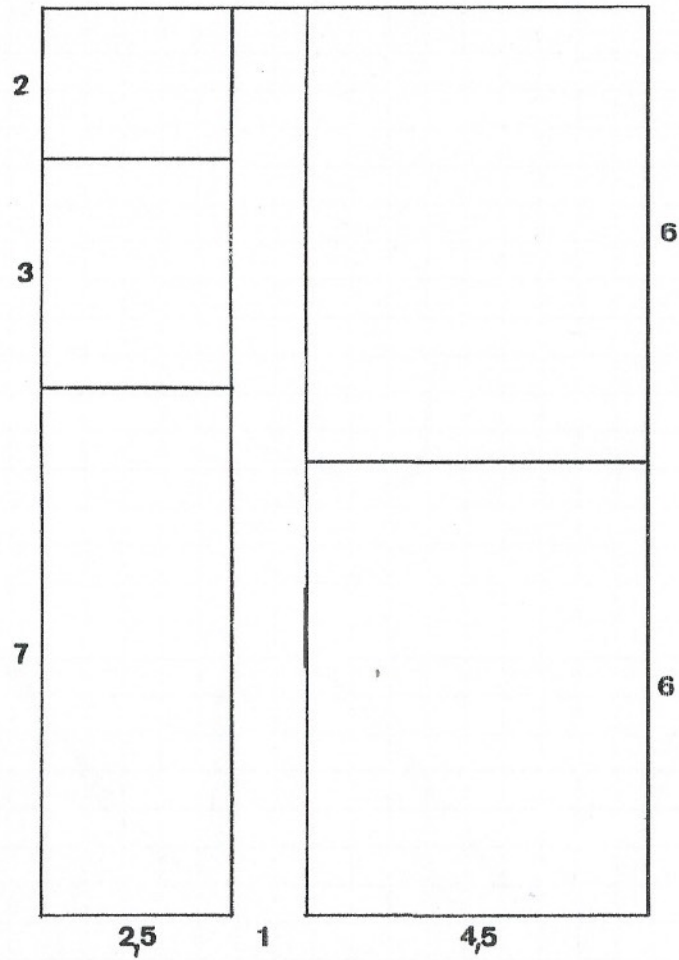

Corrigé

Plan de la ferme

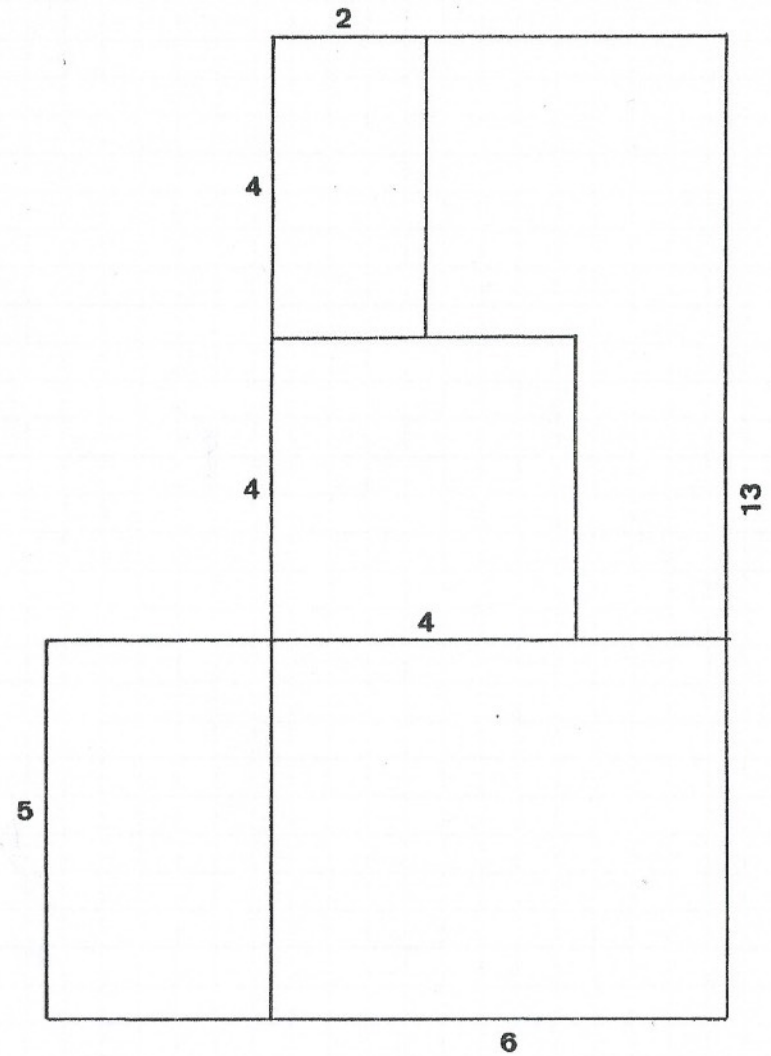

Dessine le plan de l'appartement

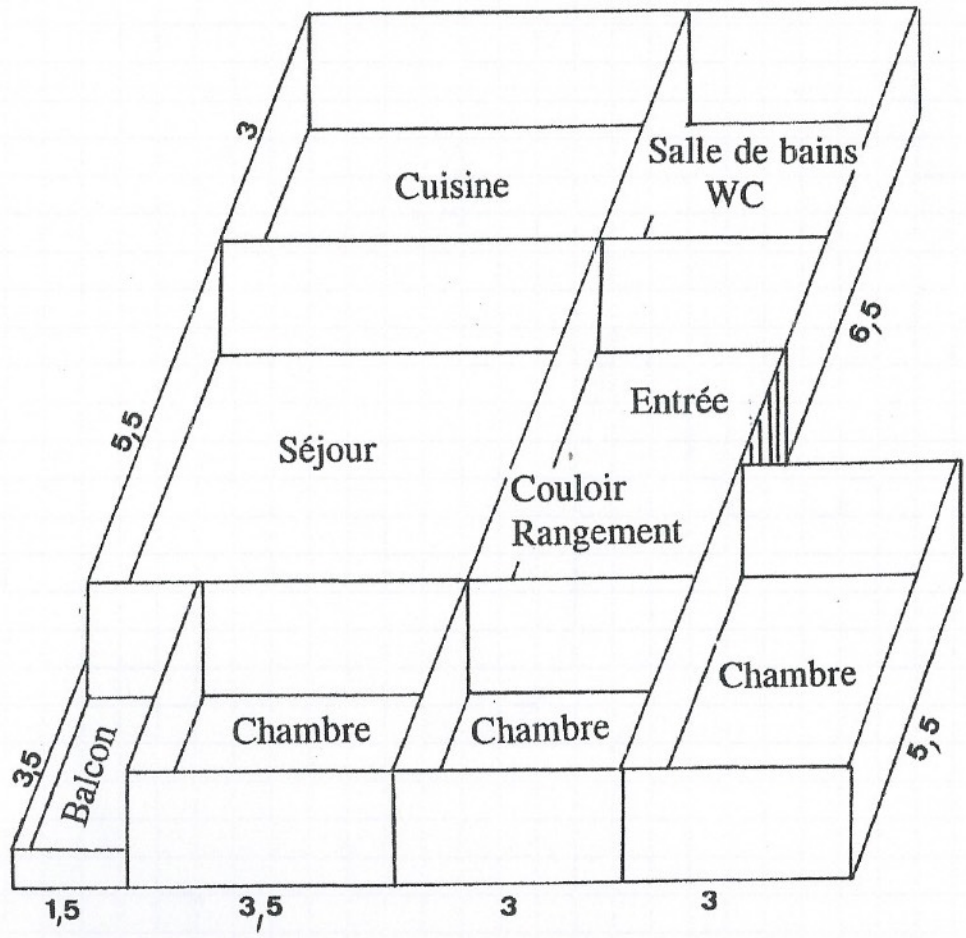

Dessine le plan de la ferme alsacienne

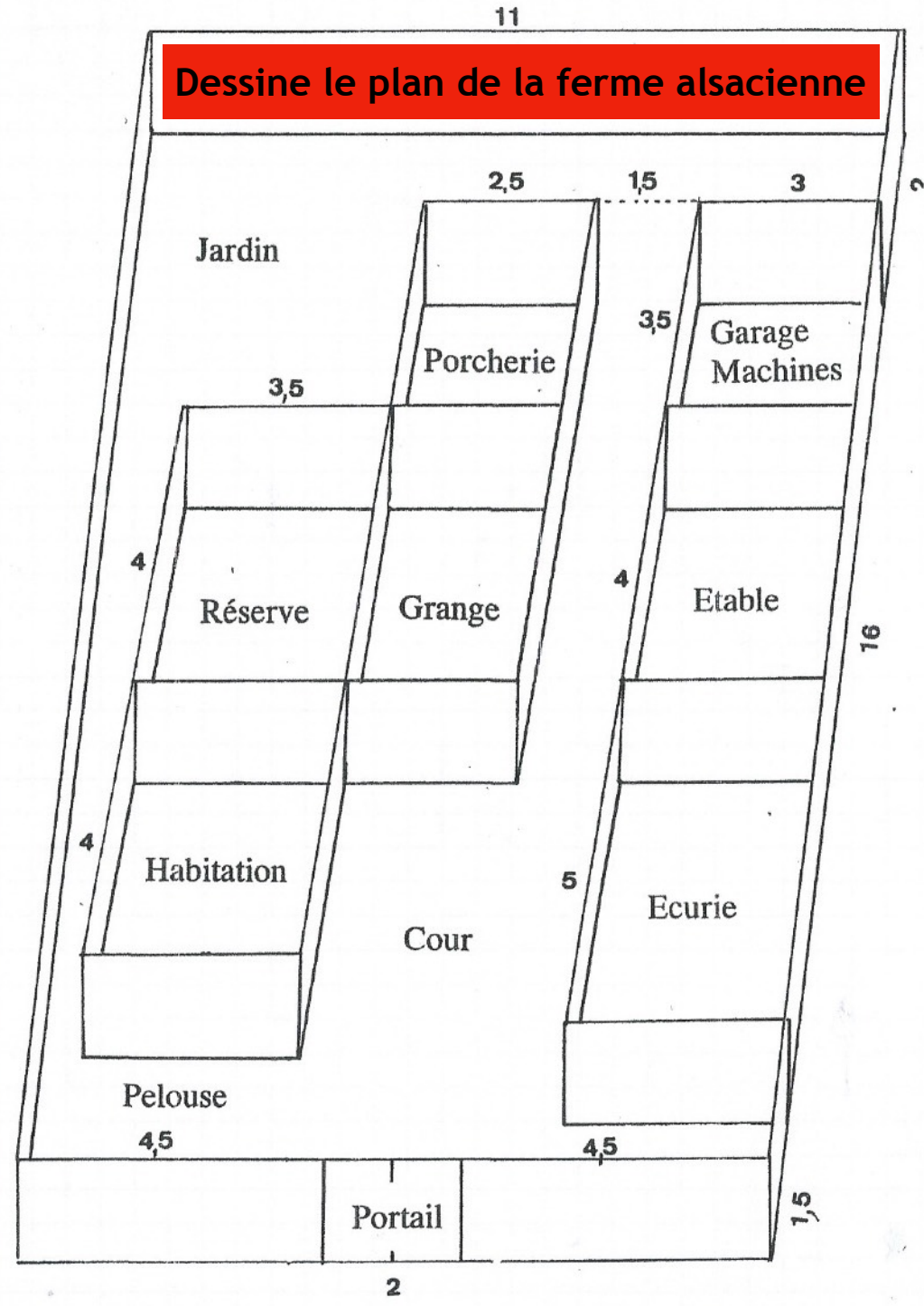

Corrigé

Plan de l'appartement

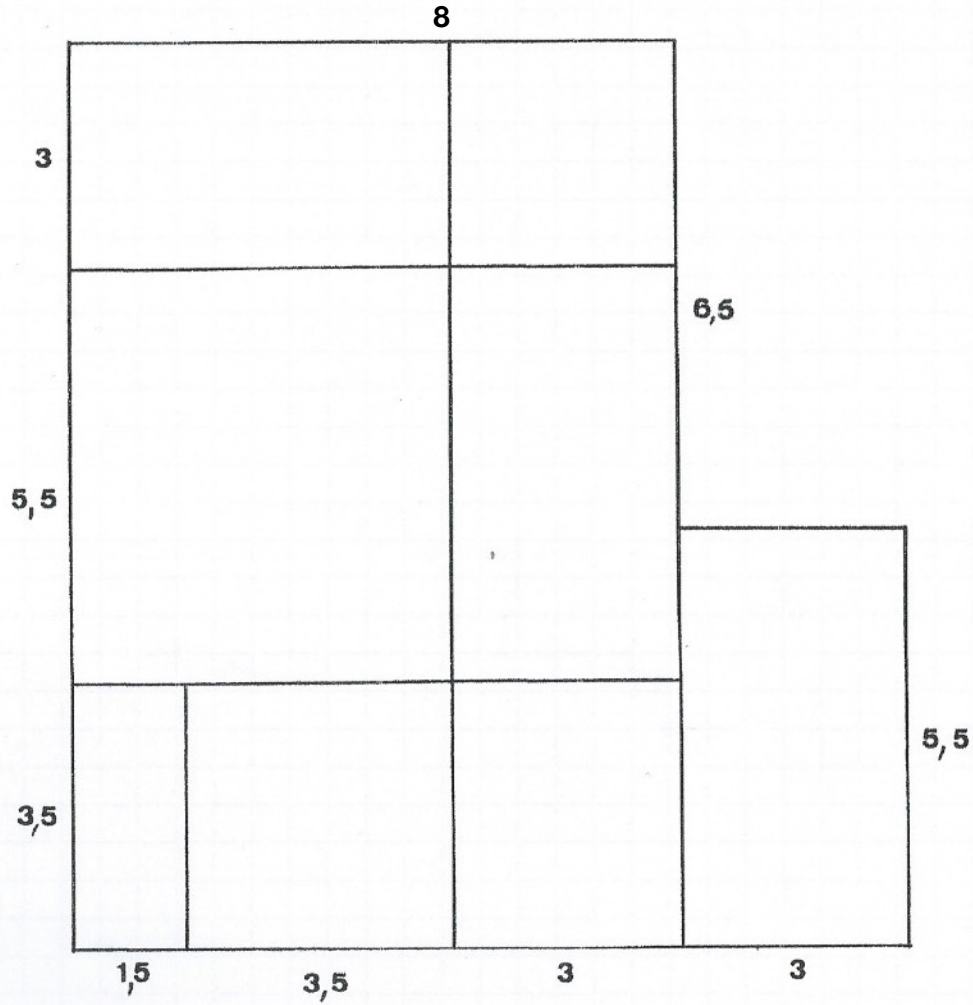

Corrigé

Plan de la ferme alsacienne

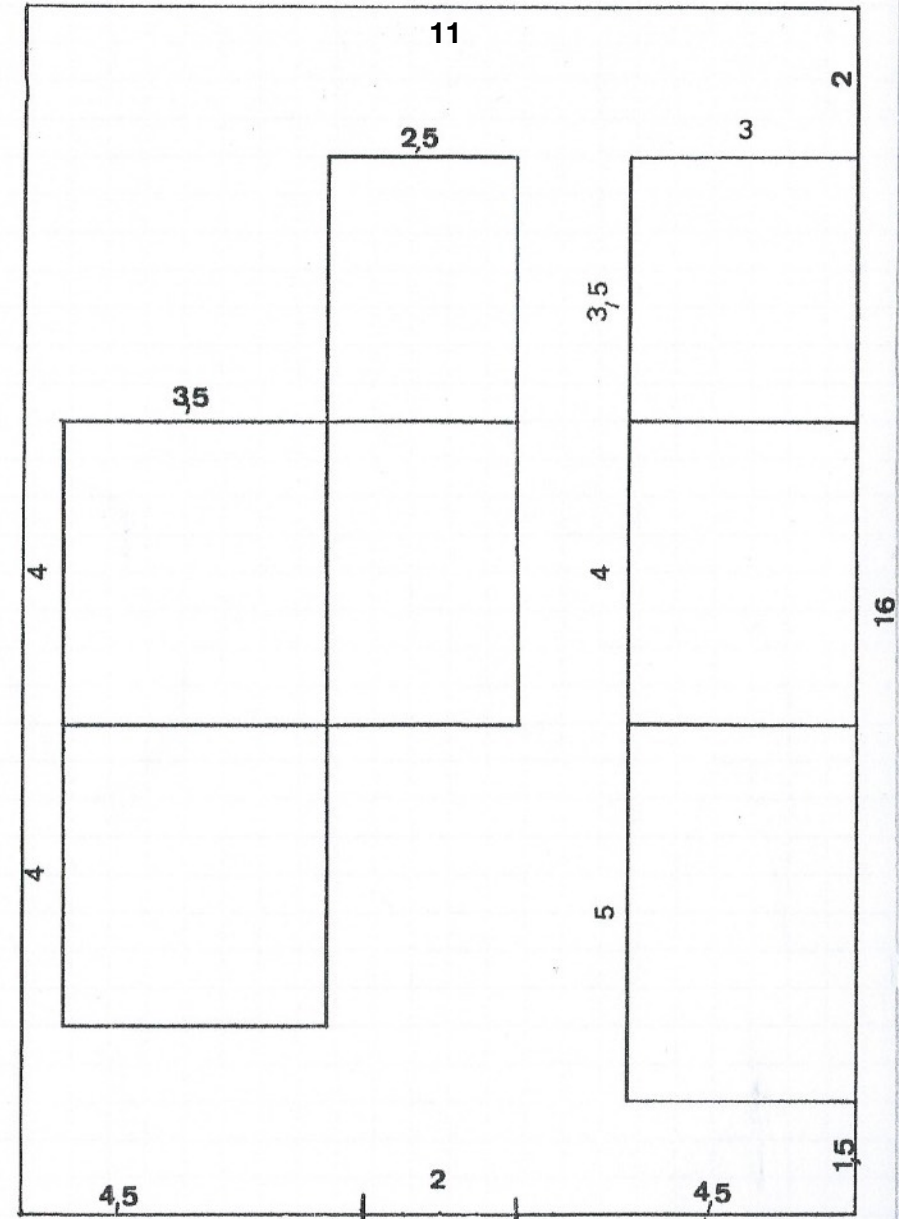

Dessine le plan de l'église

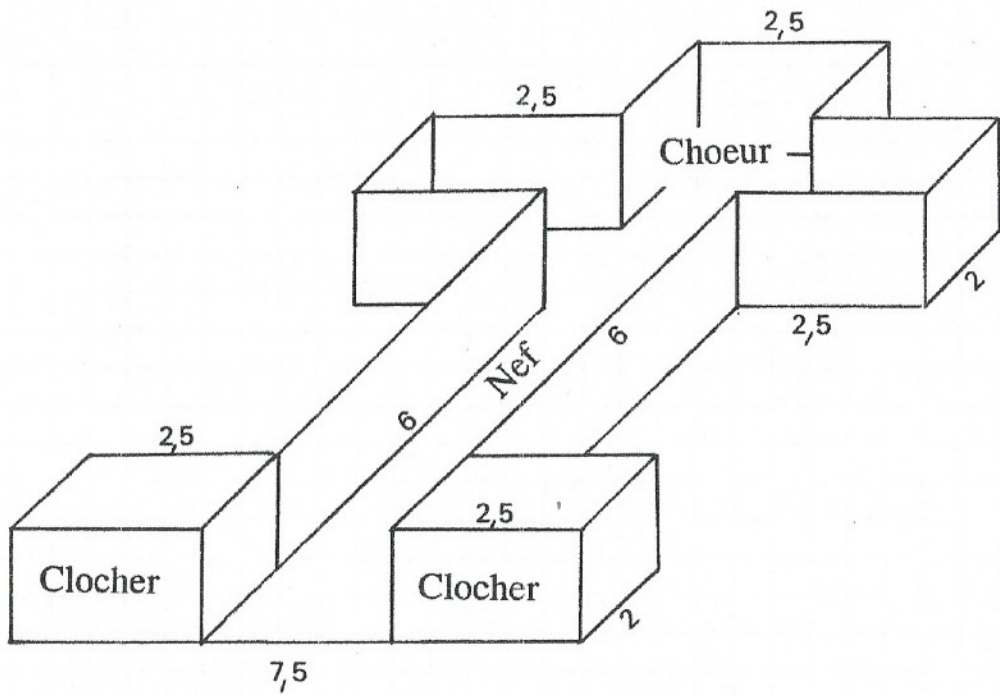

Dessine le plan de l'atelier

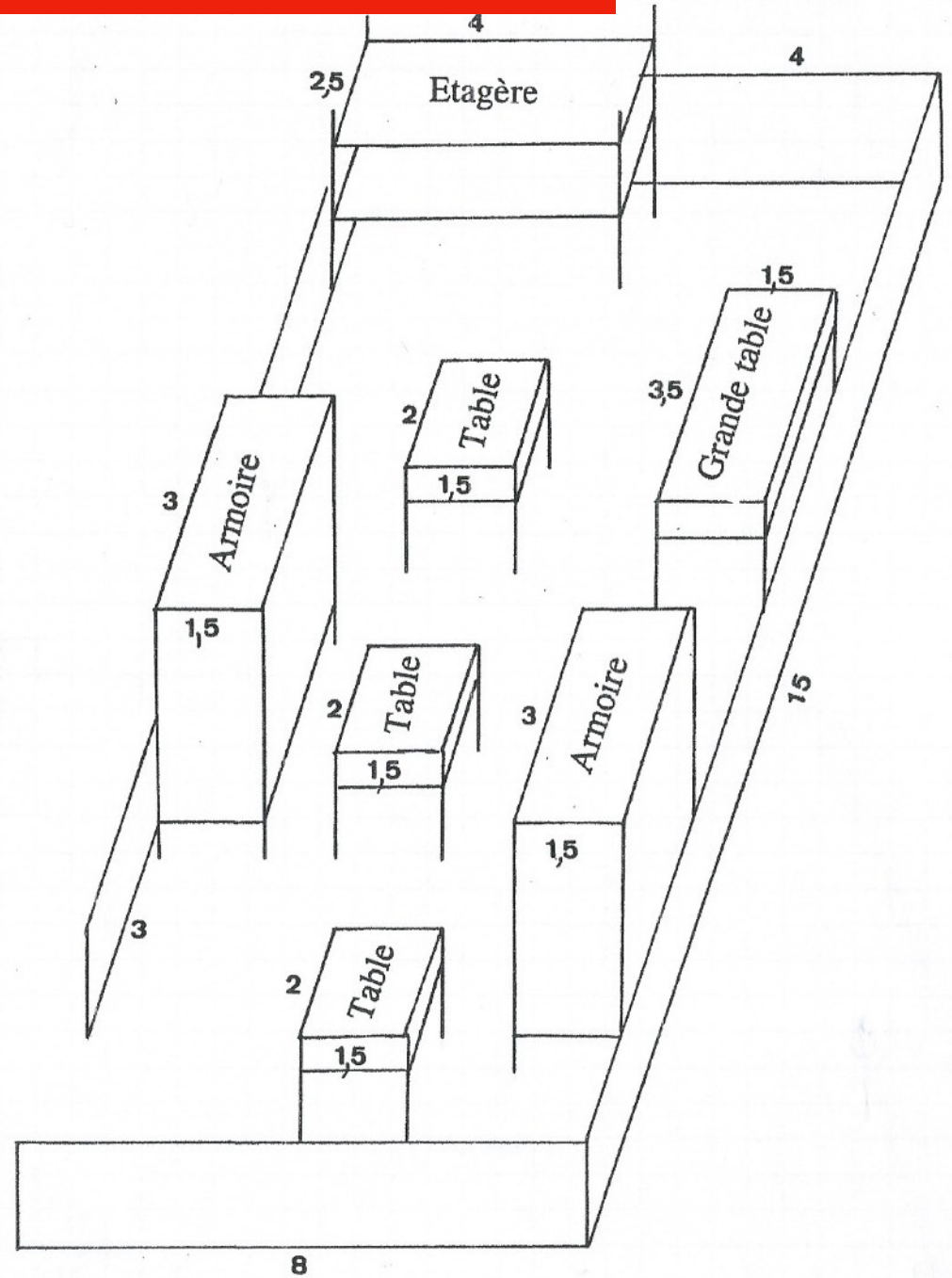

Corrigé

Plan de l'église

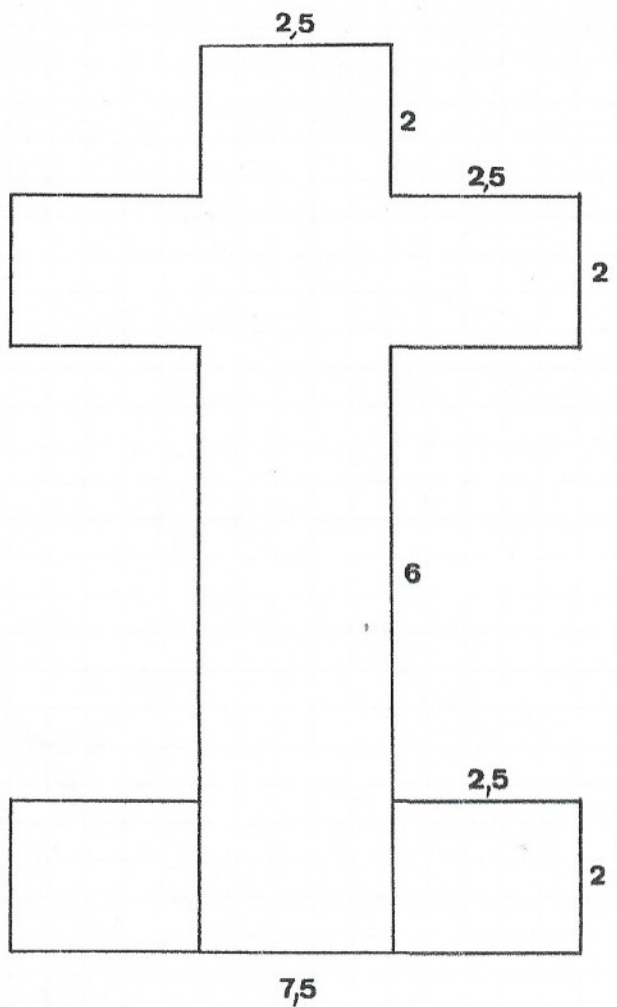

Corrigé

Plan de l'atelier

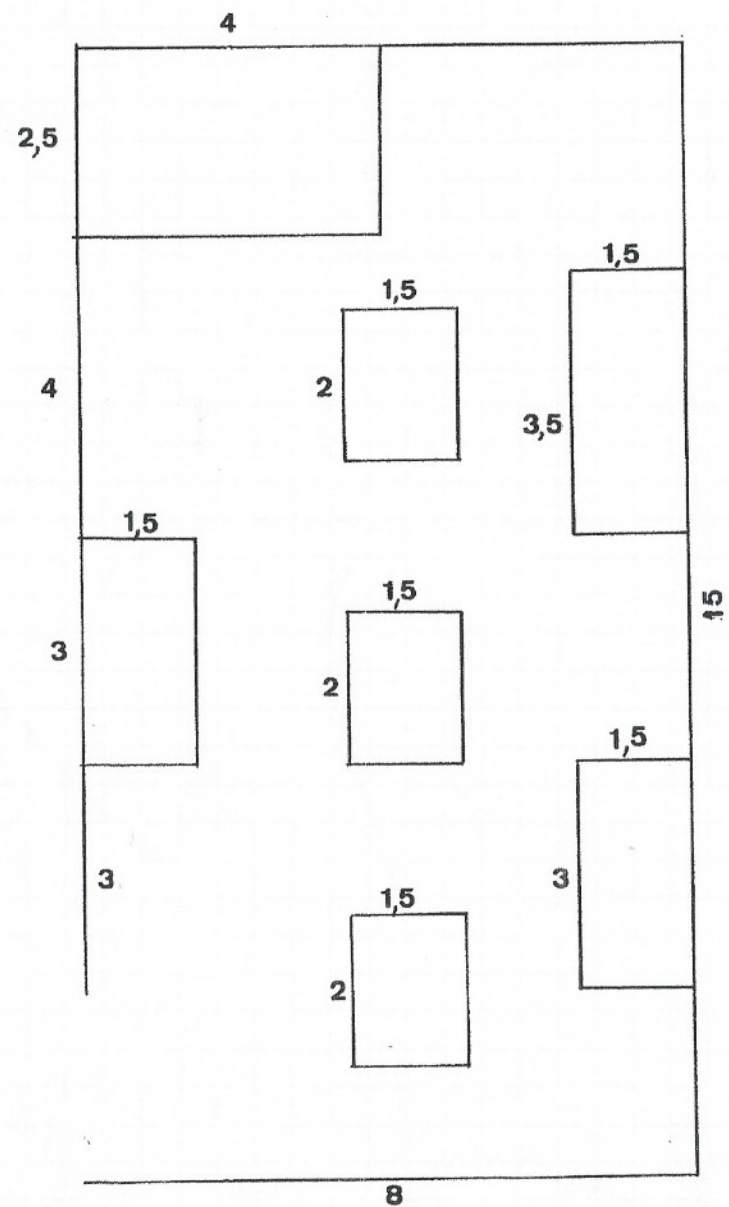

Dessine le plan du château fort

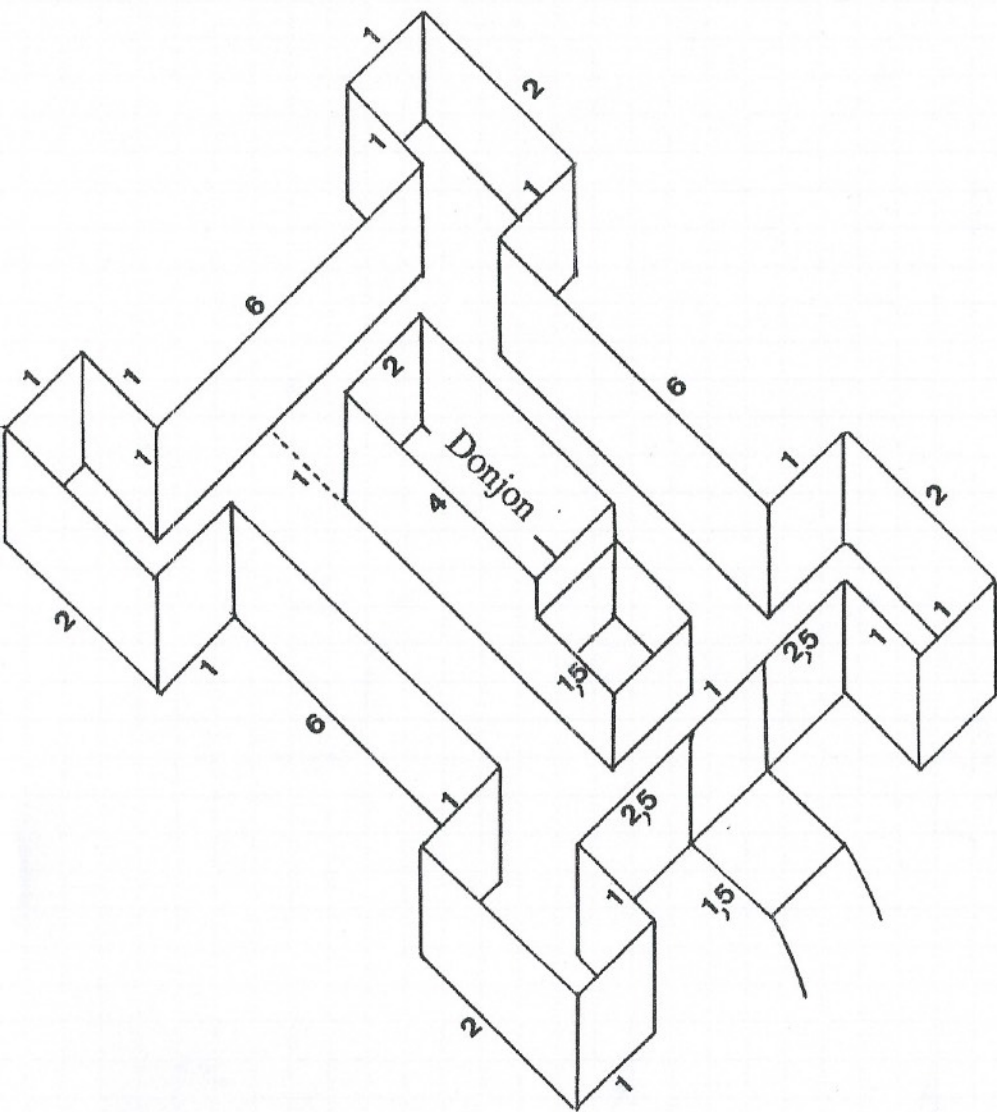

Dessine le plan du musée

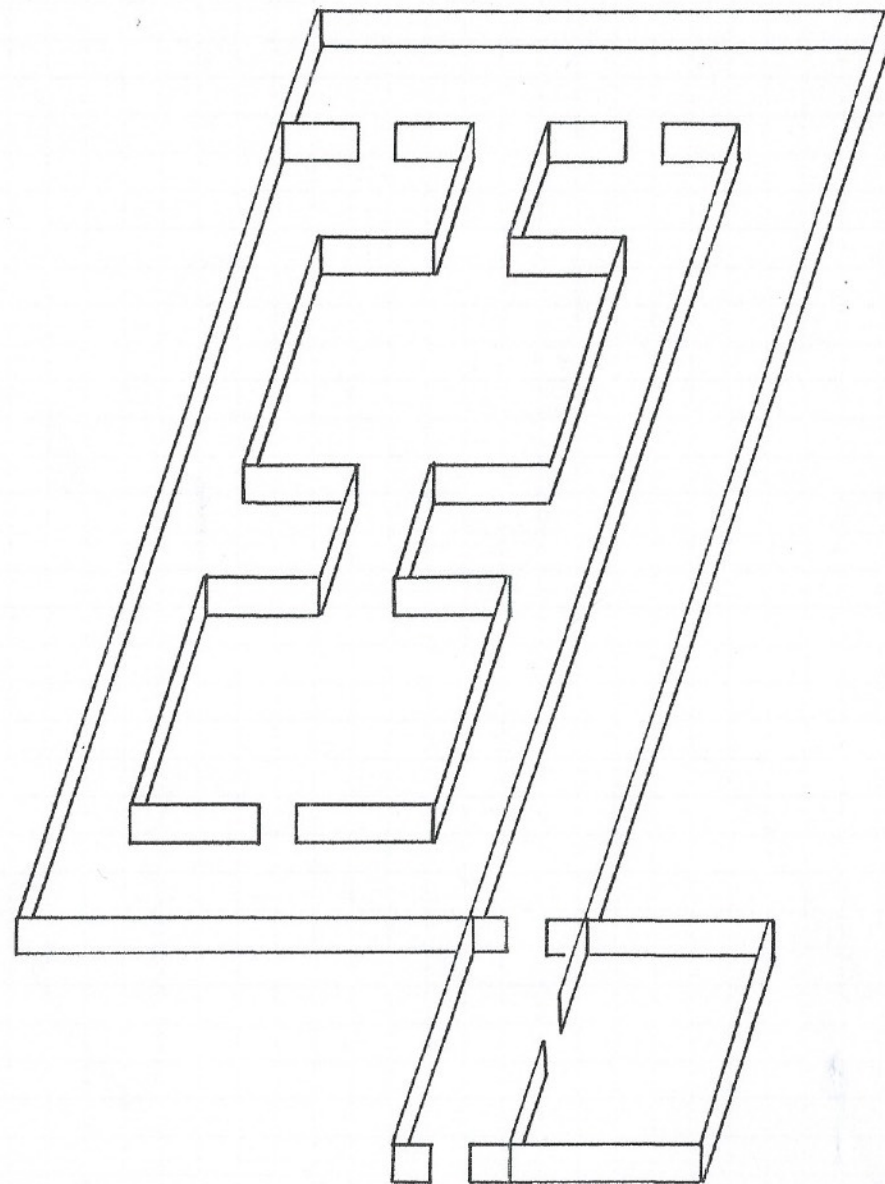

Corrigé

Plan du château fort

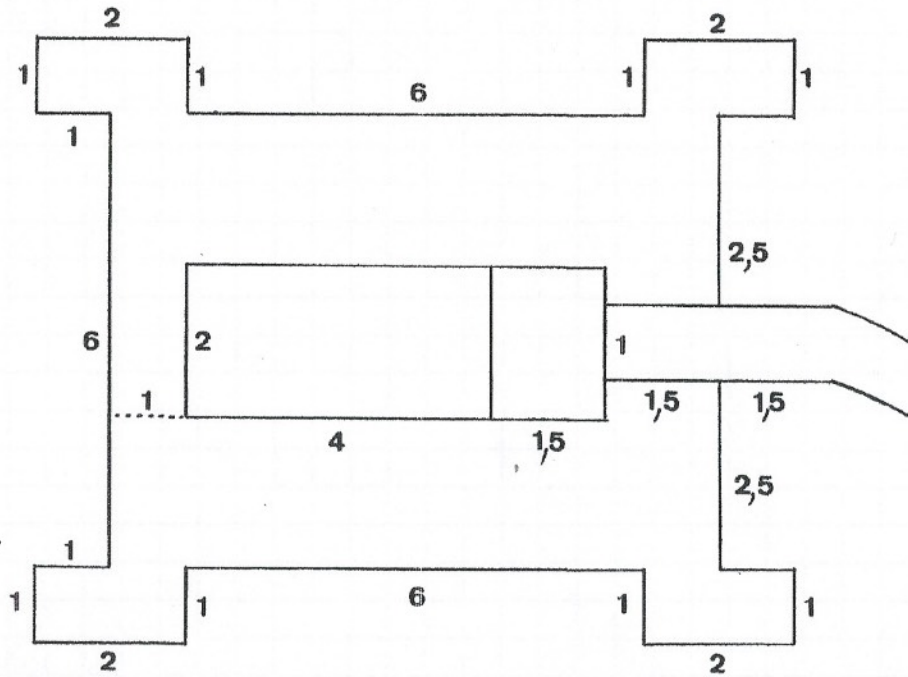

Corrigé

Plan du musée

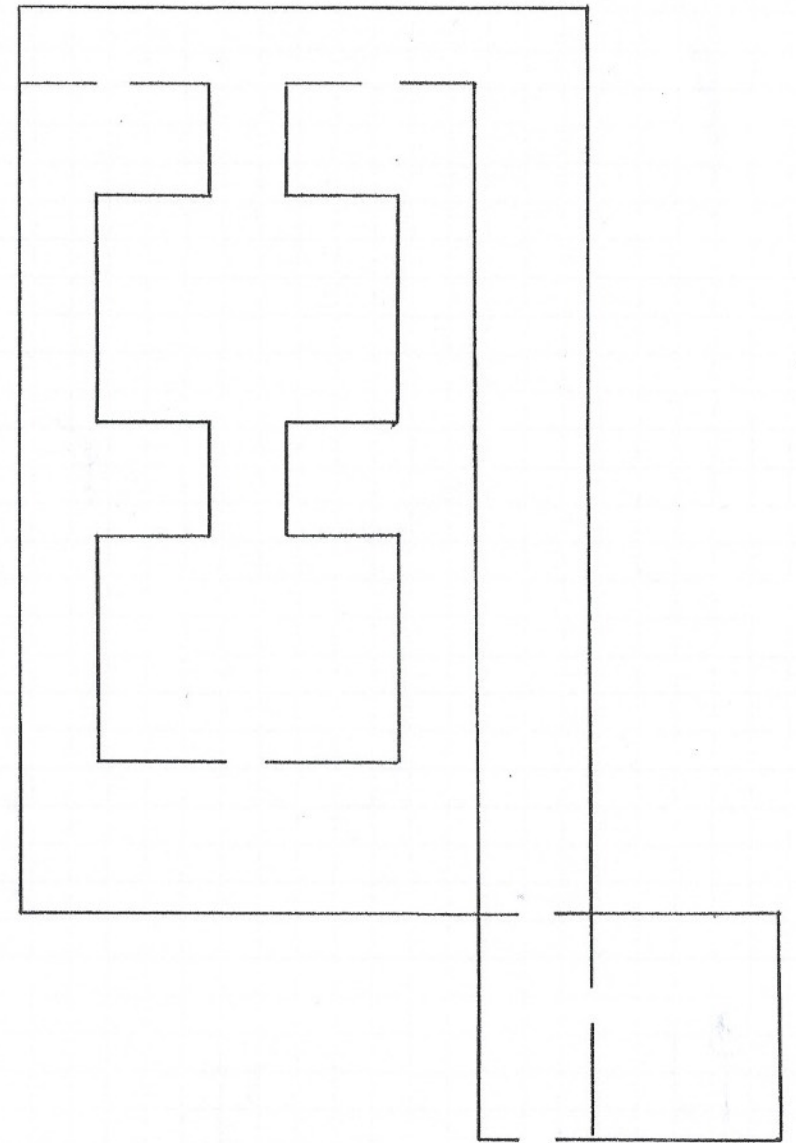

Dessine le plan de cette chambre

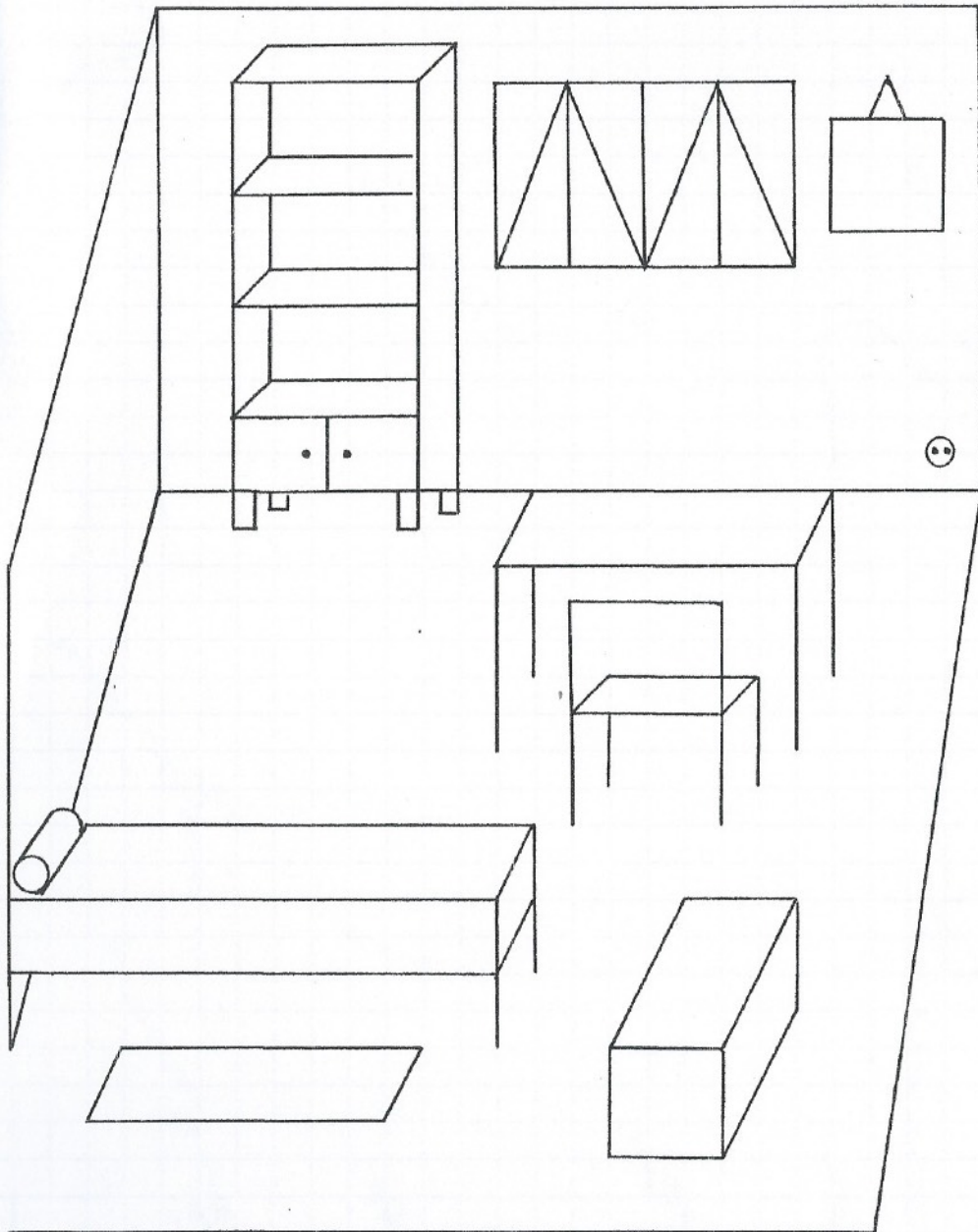

TEST

Dessine le plan du jardin et des 4 maisonnettes.

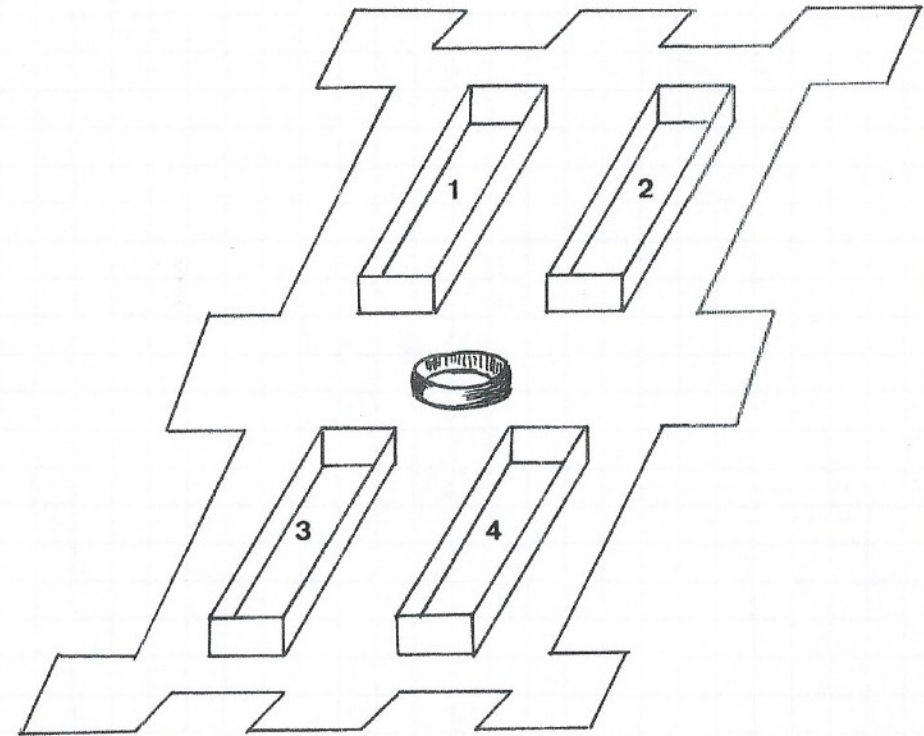

Corrigé

le plan de cette chambre

