

HAUTEUR DES PILES 6 cm

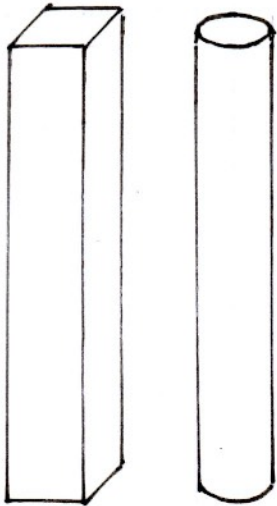

1

2

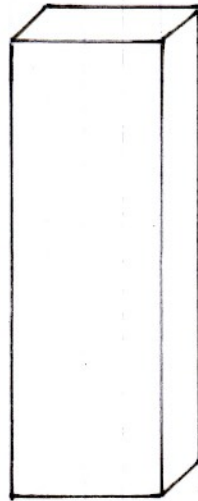

3

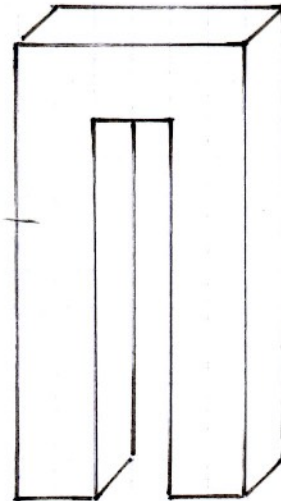

4



5

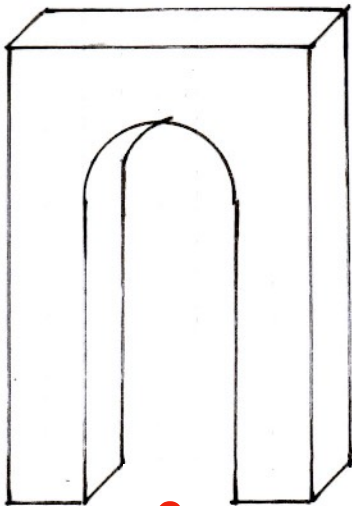

6

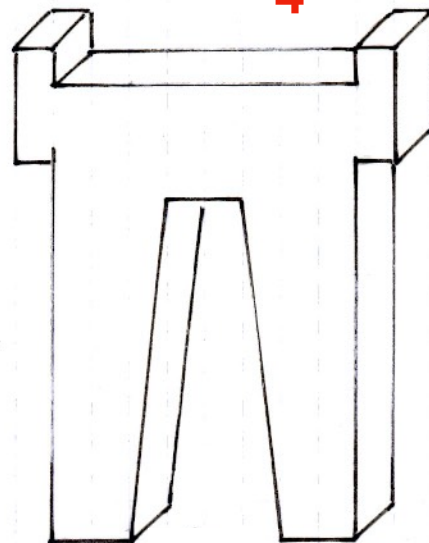

7

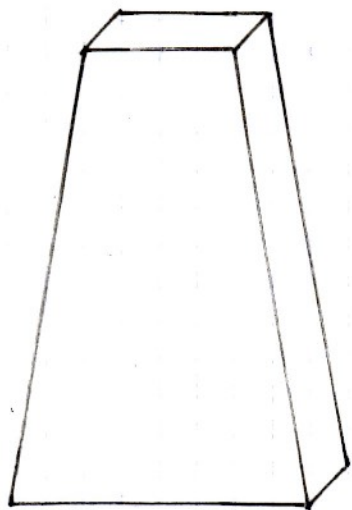

8

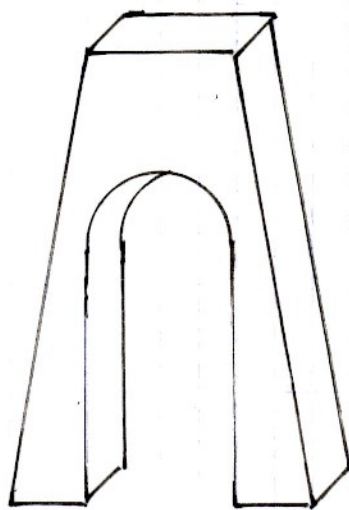

9

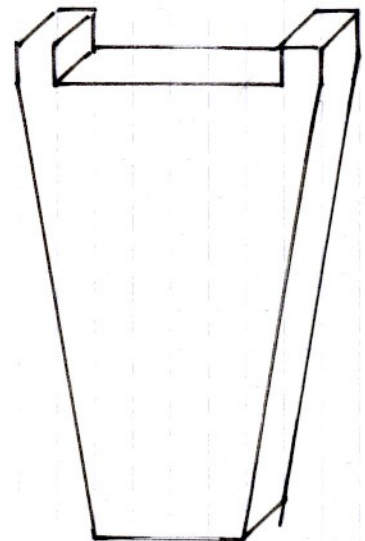

10

11 grande pile portant l'autoroute

12 tunnel de passage d'autoroute

1

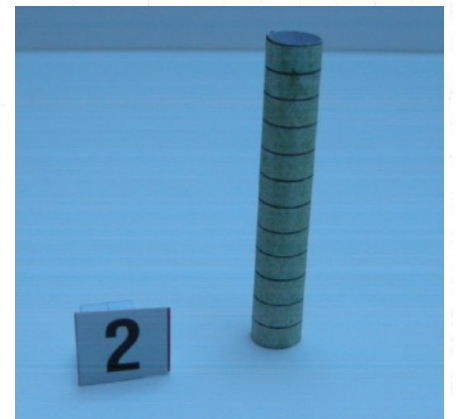
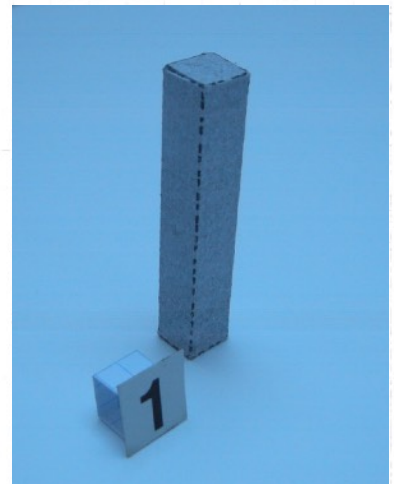
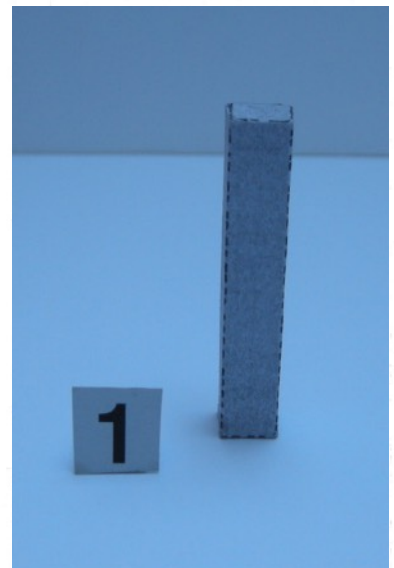
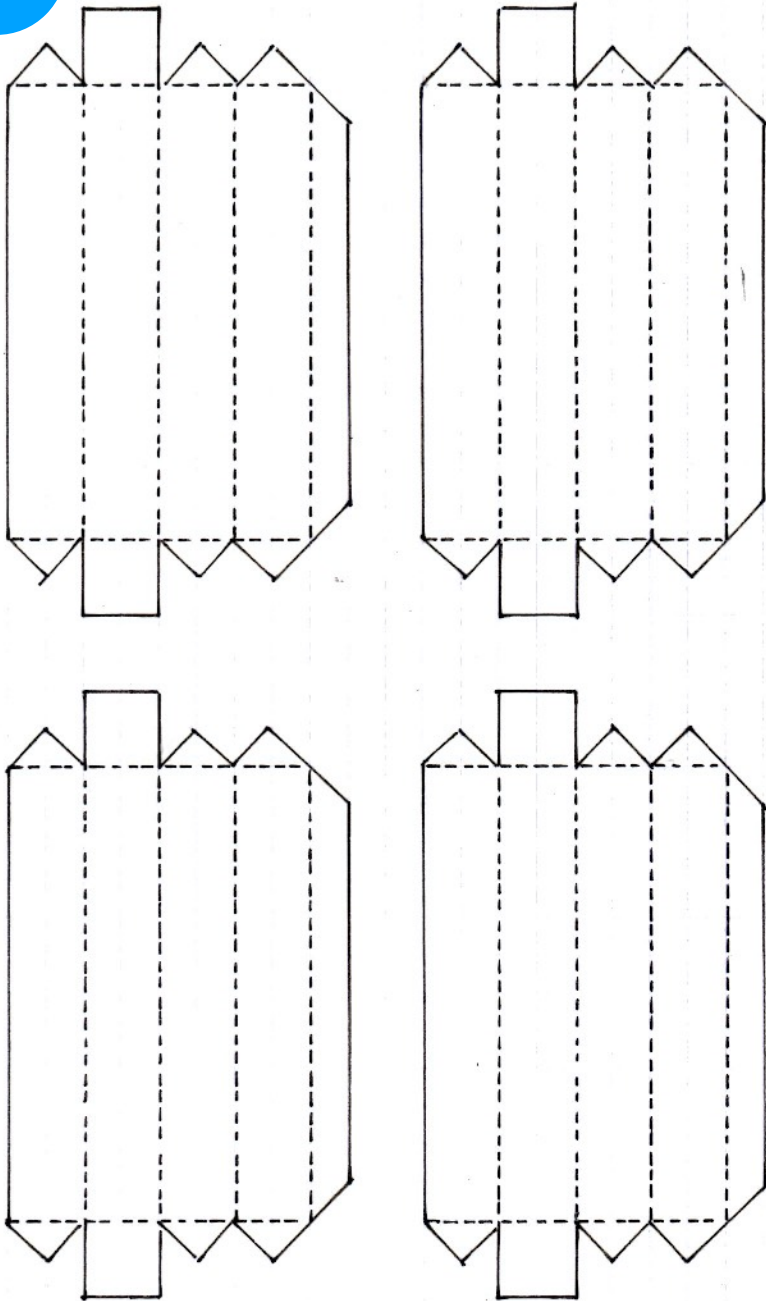

2



Pour vous aider, allez voir dans « Trucs et astuces »
Fabriquer des colonnes ou des rondins

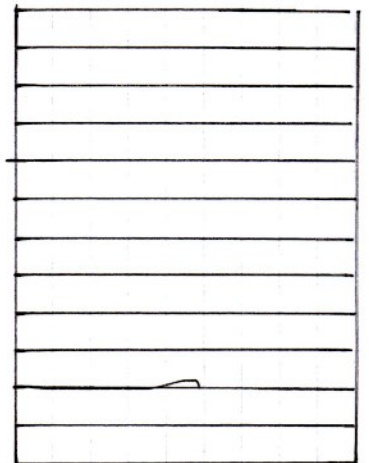
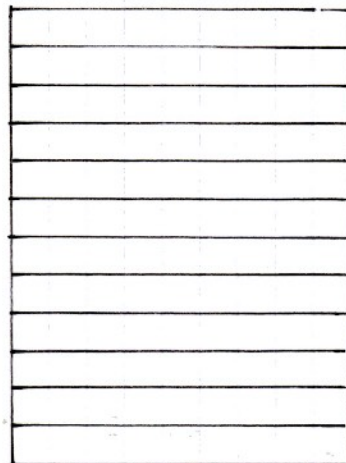
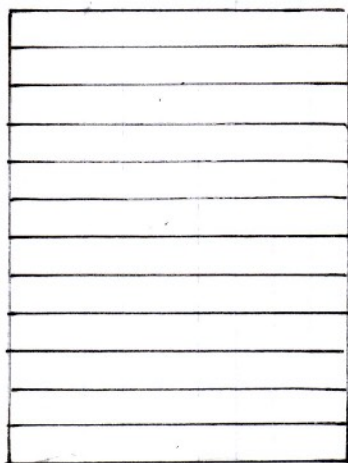
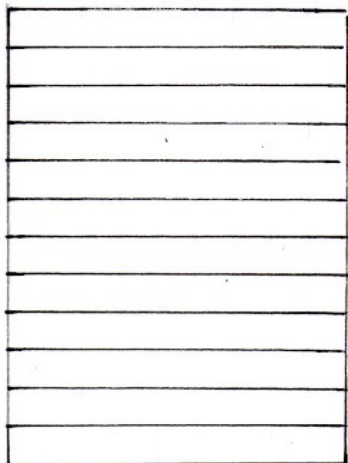

3

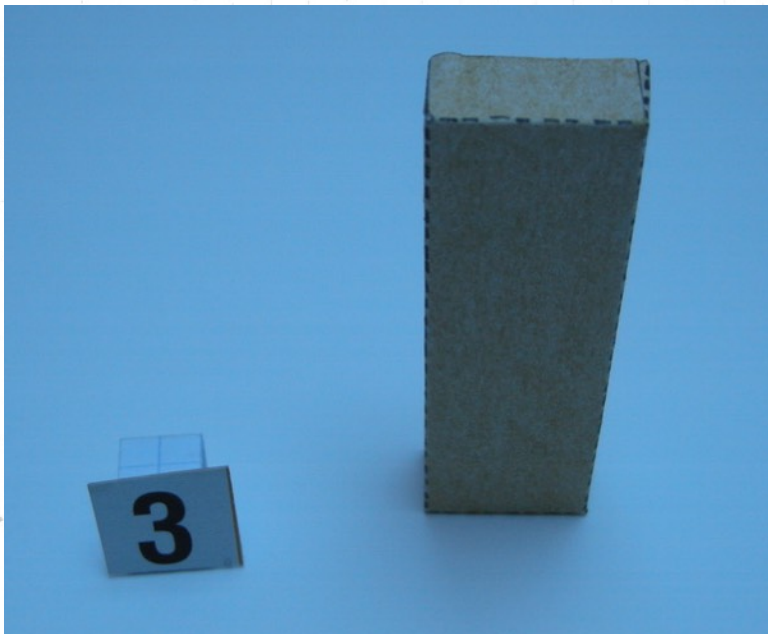
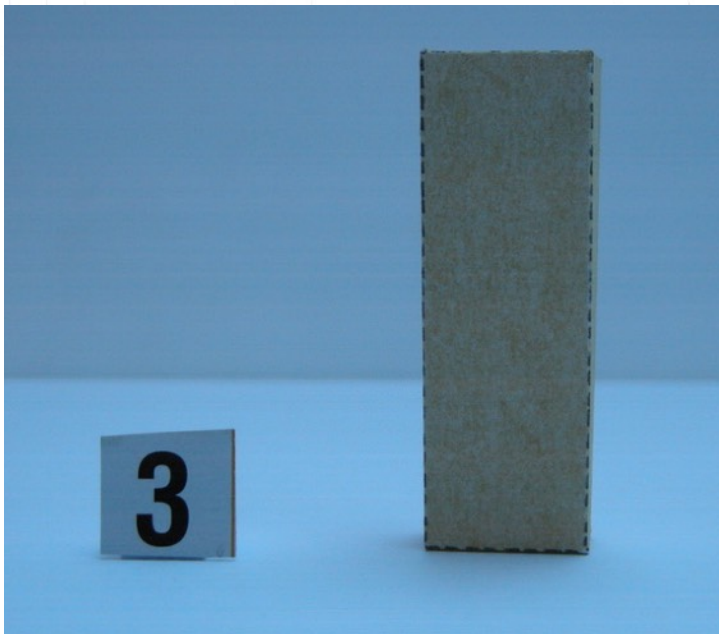
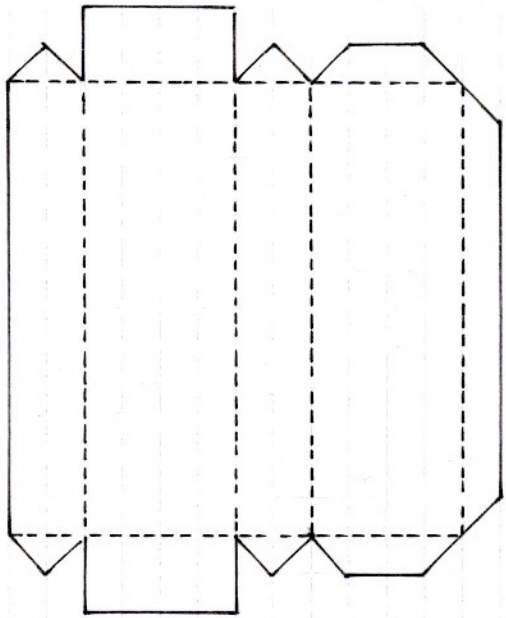
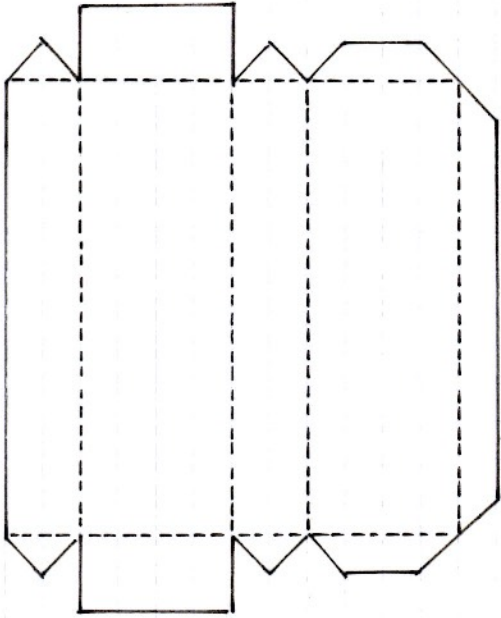
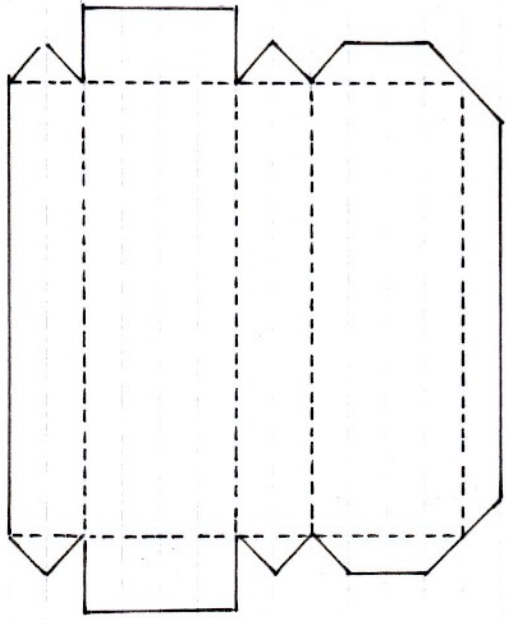
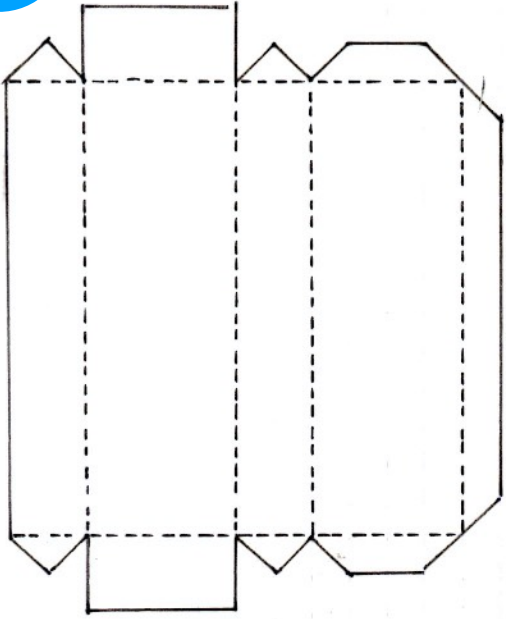

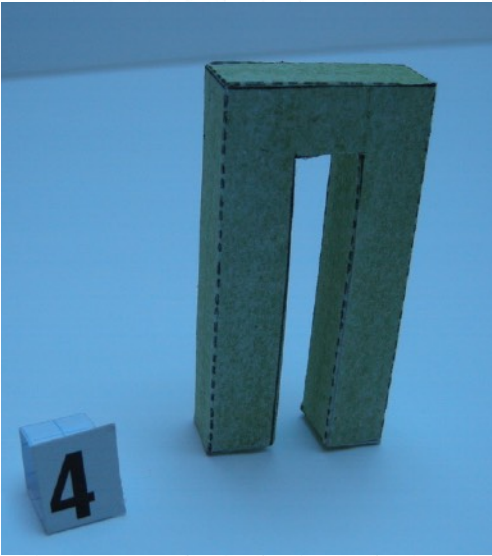
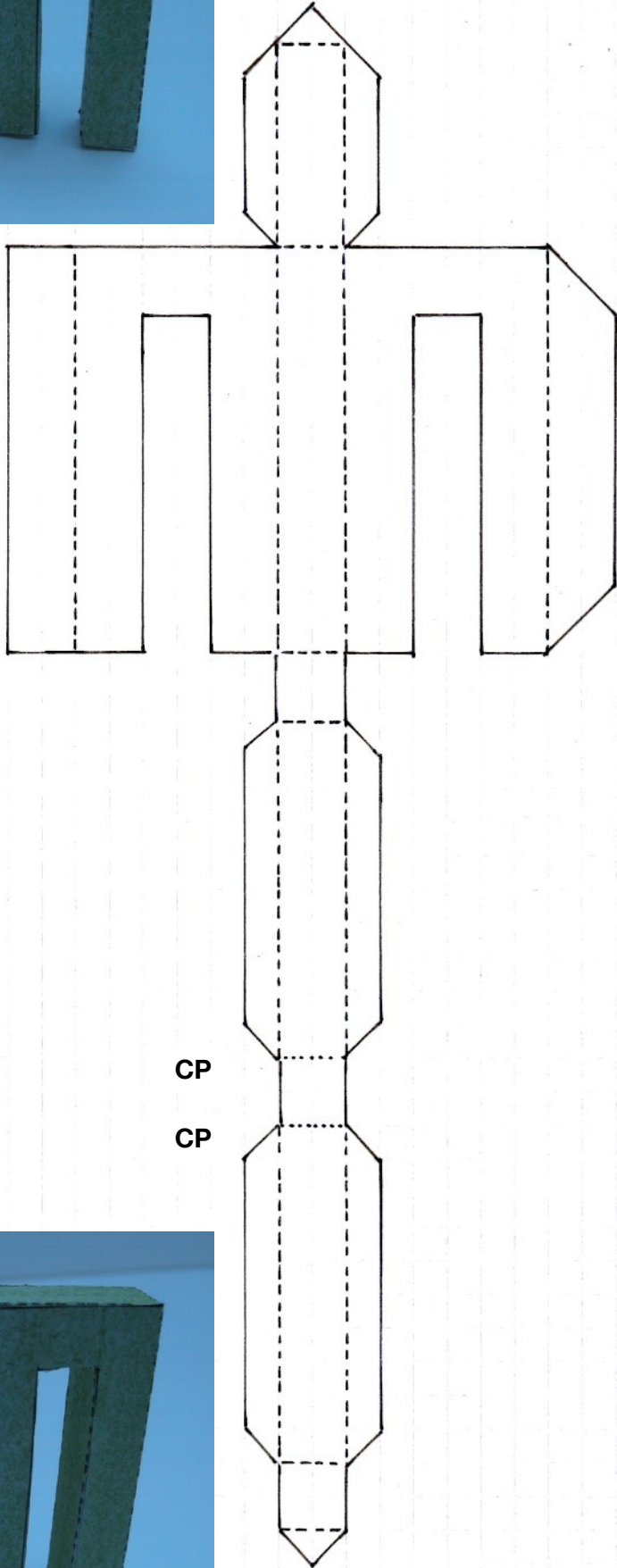
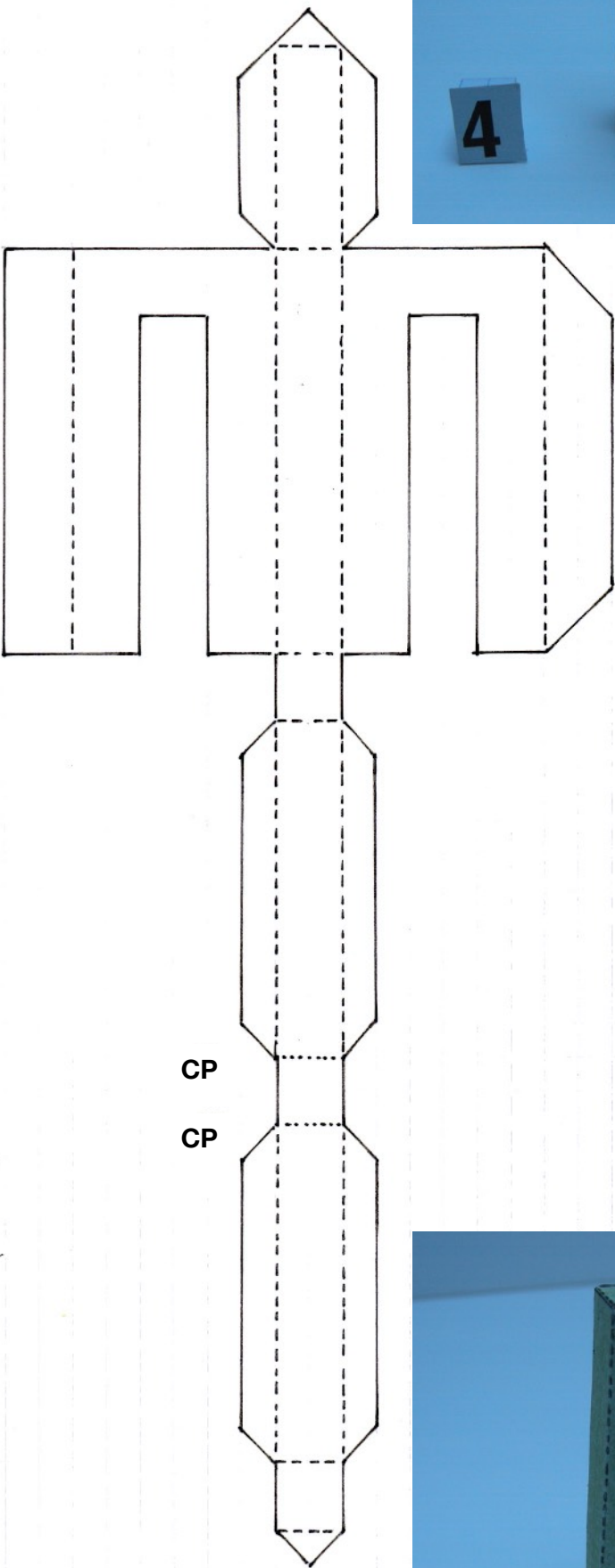
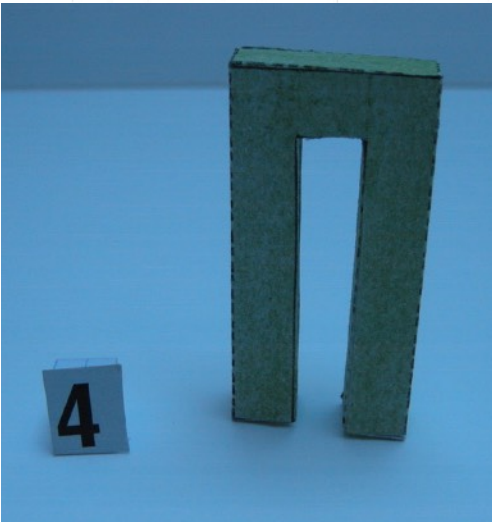

5

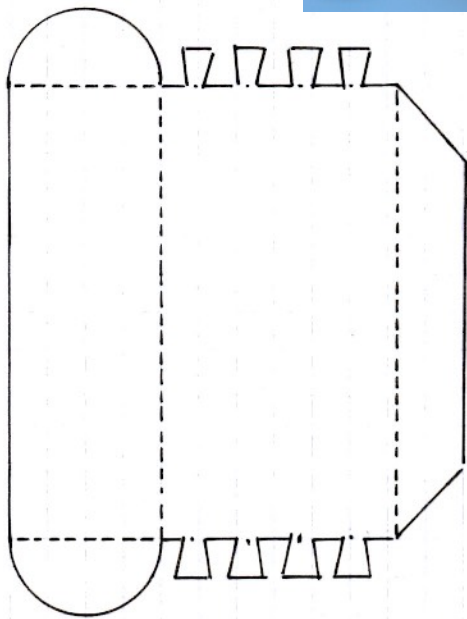
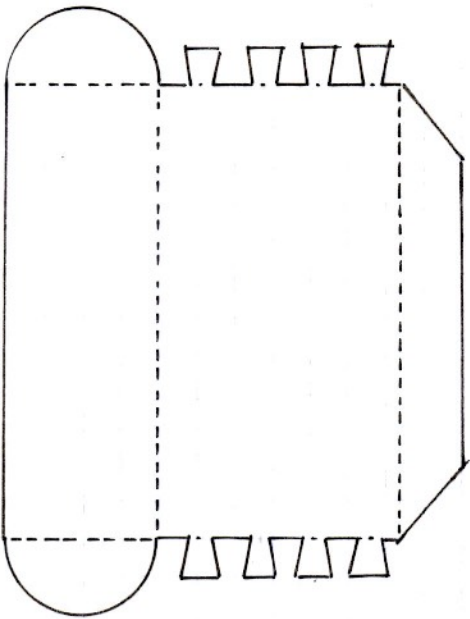
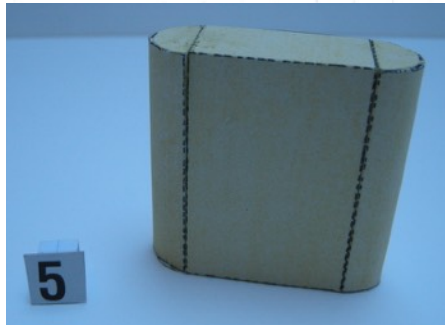
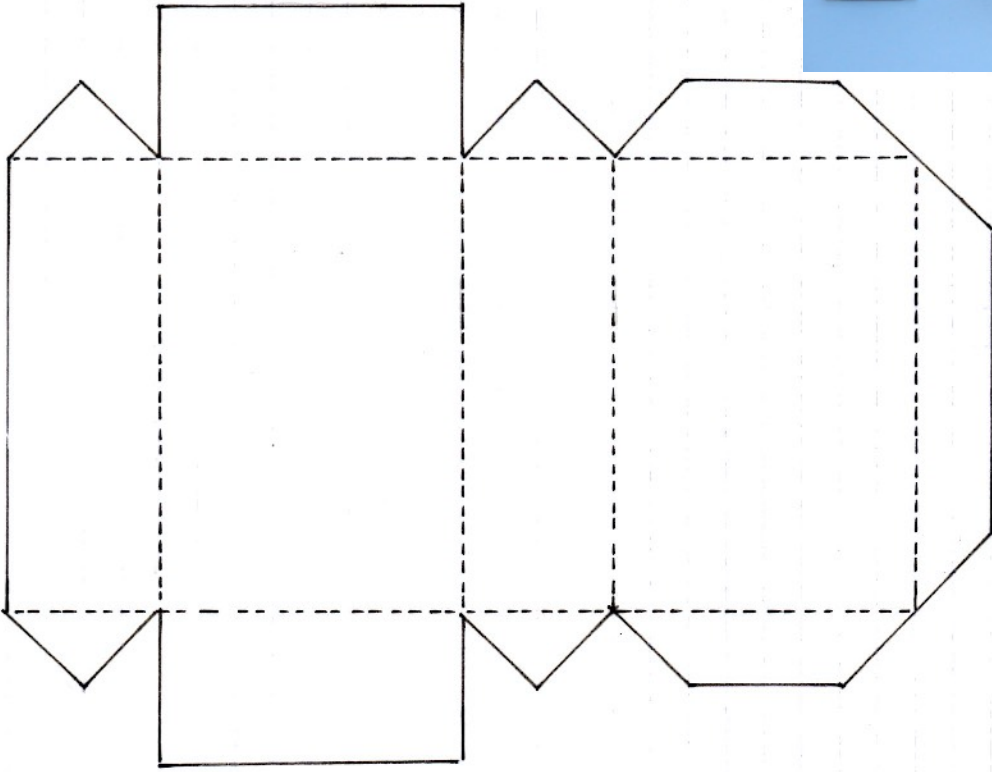
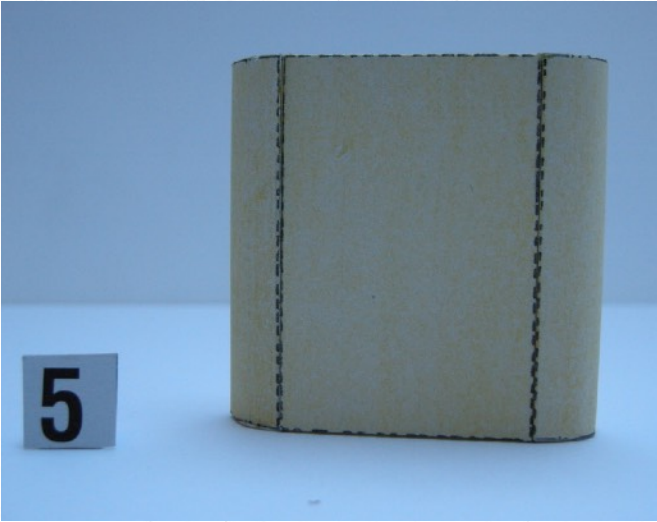
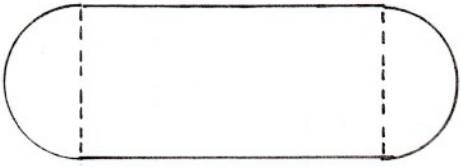

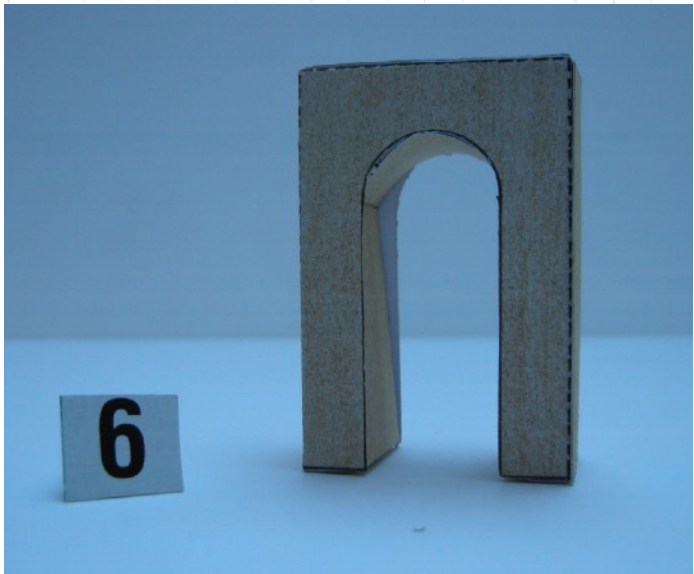
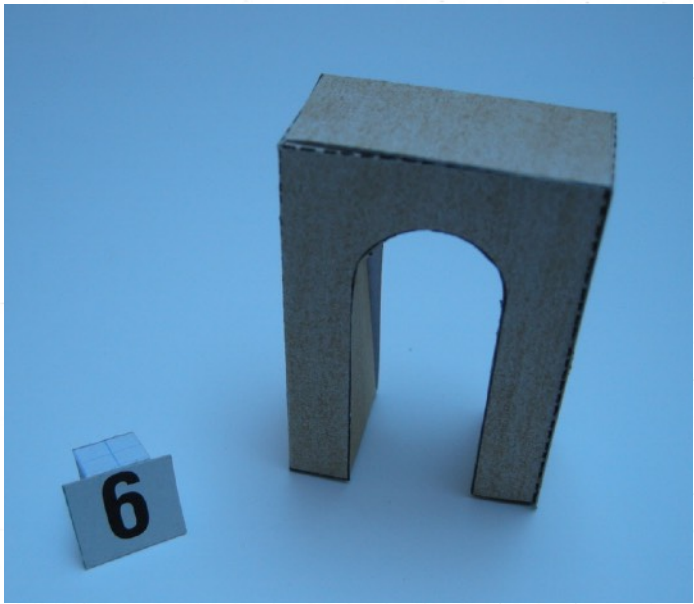
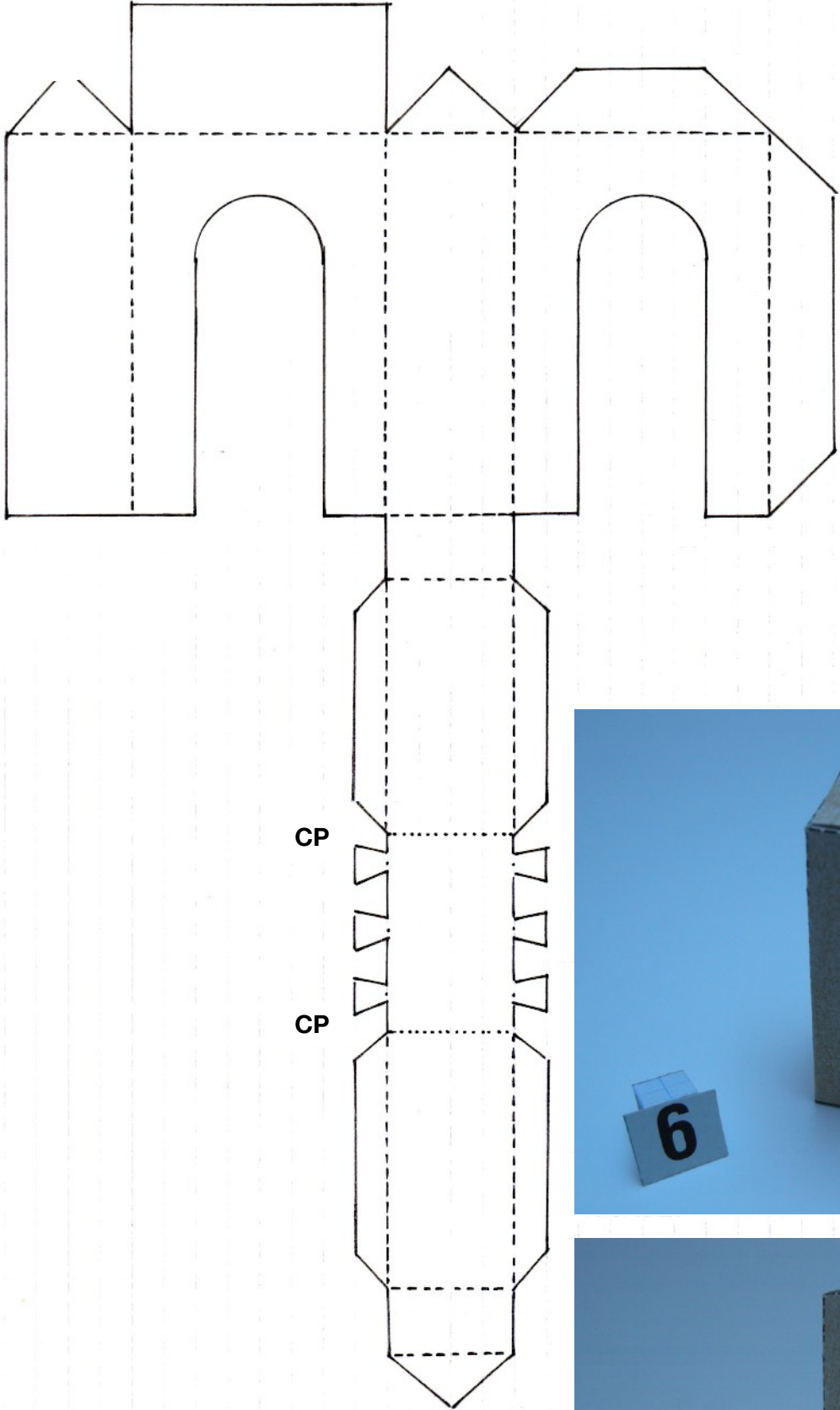

7

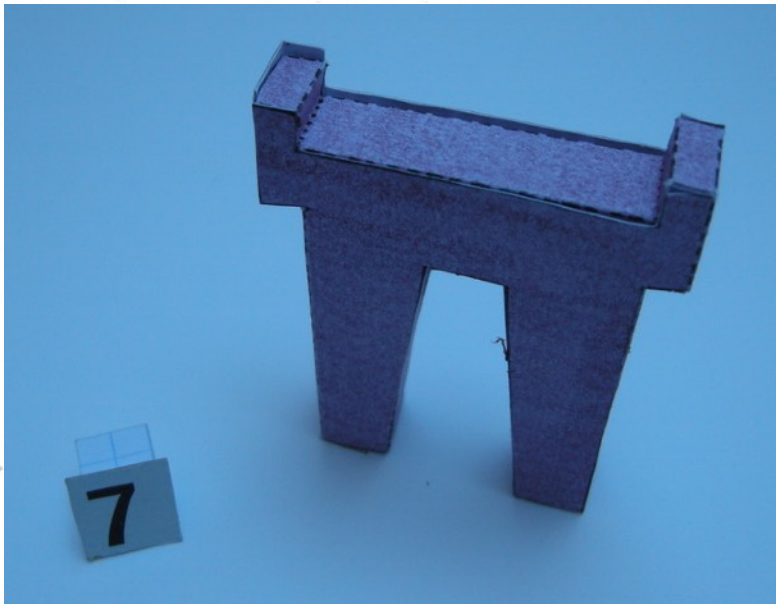
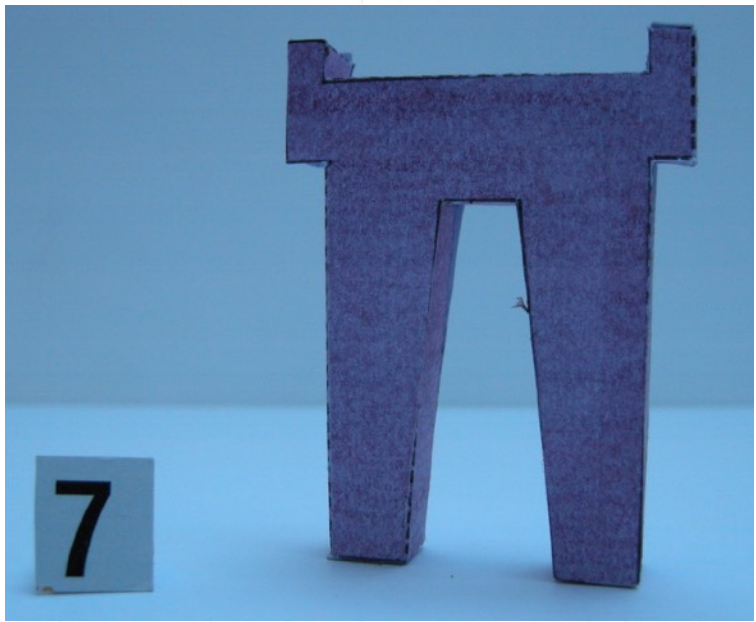
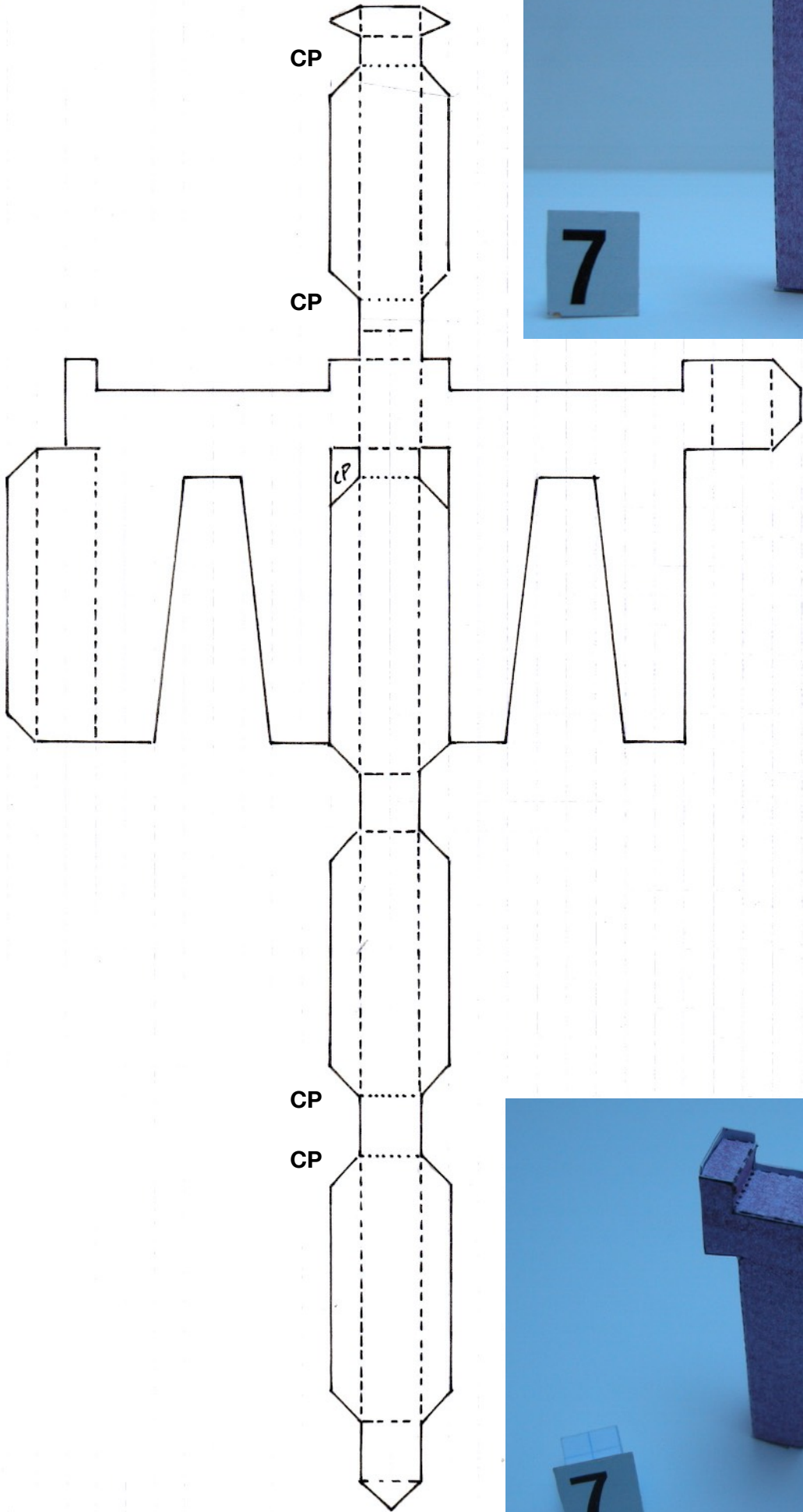

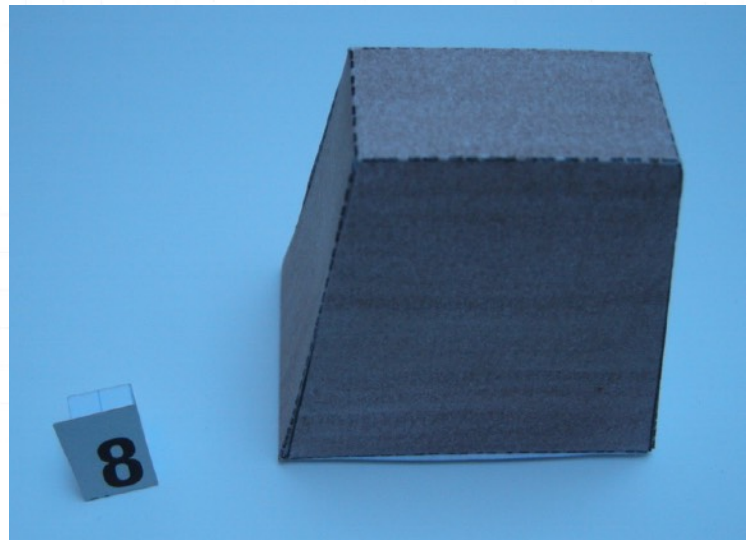
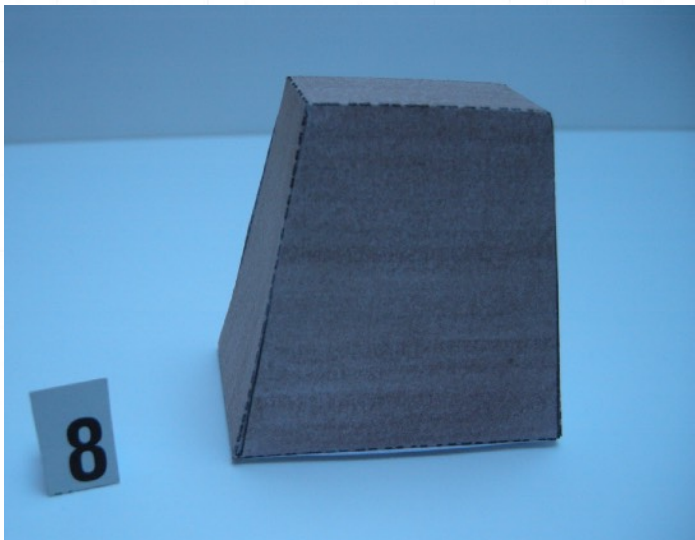
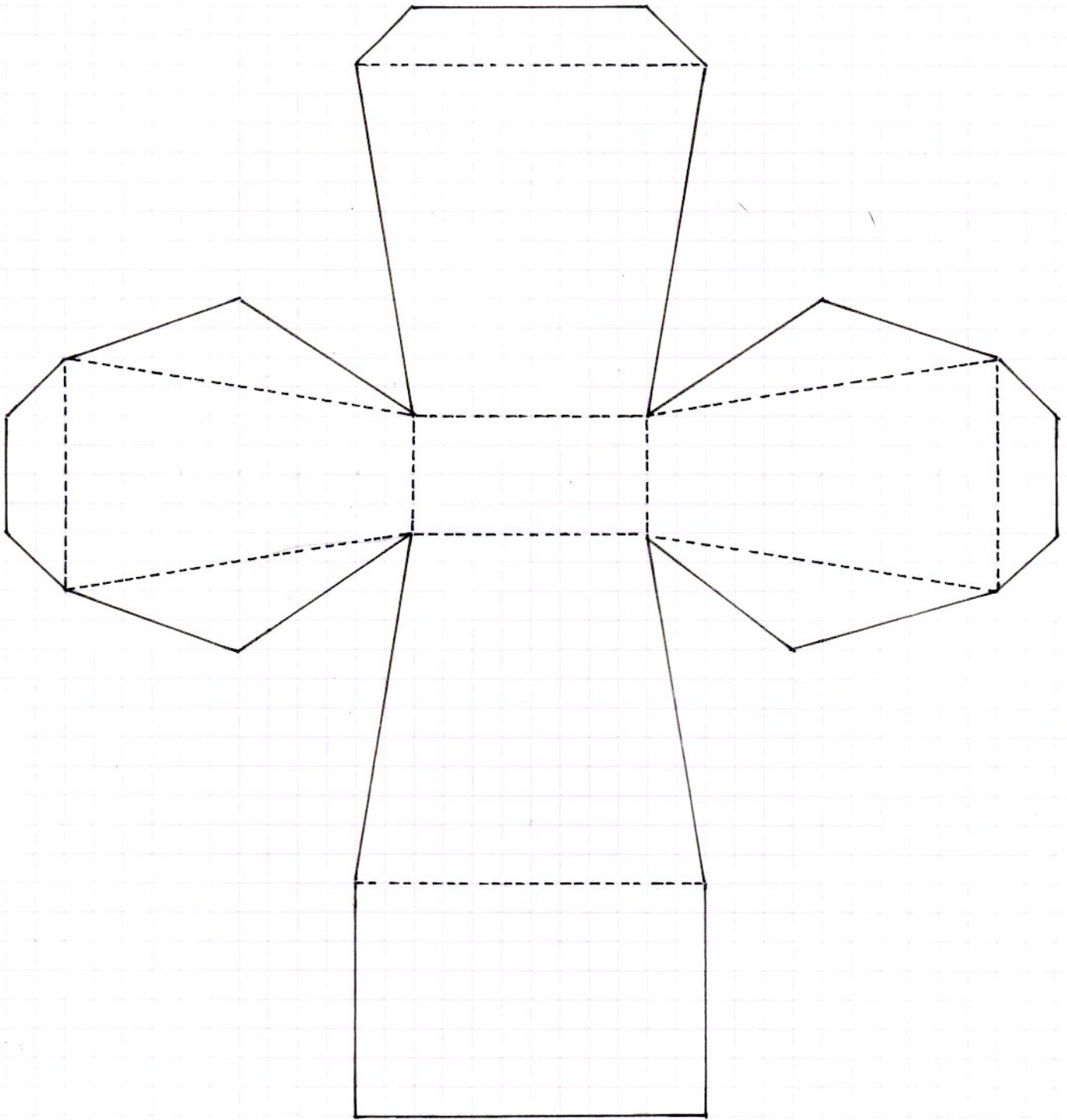

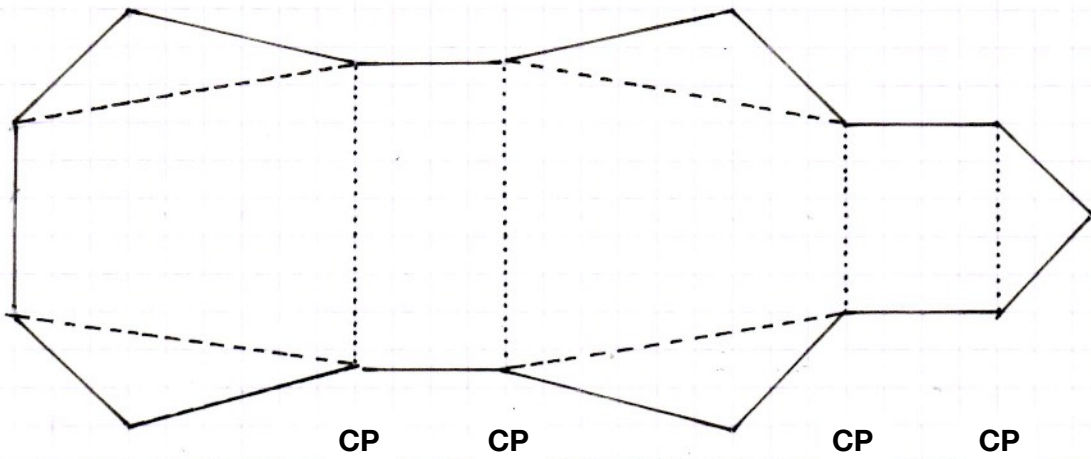
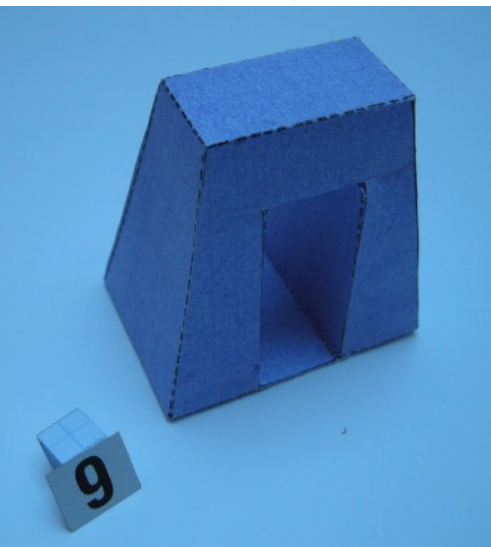
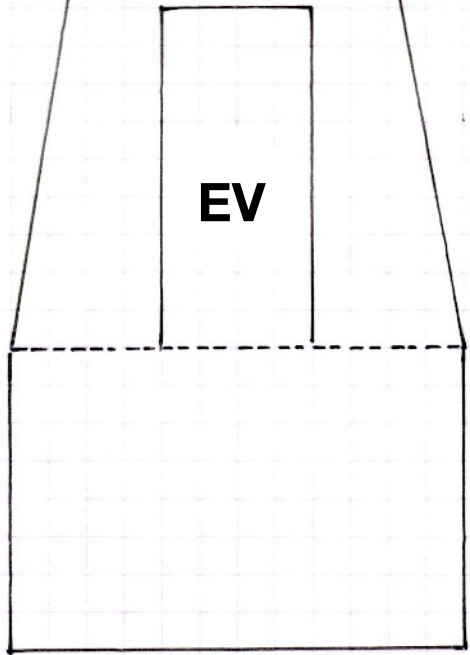
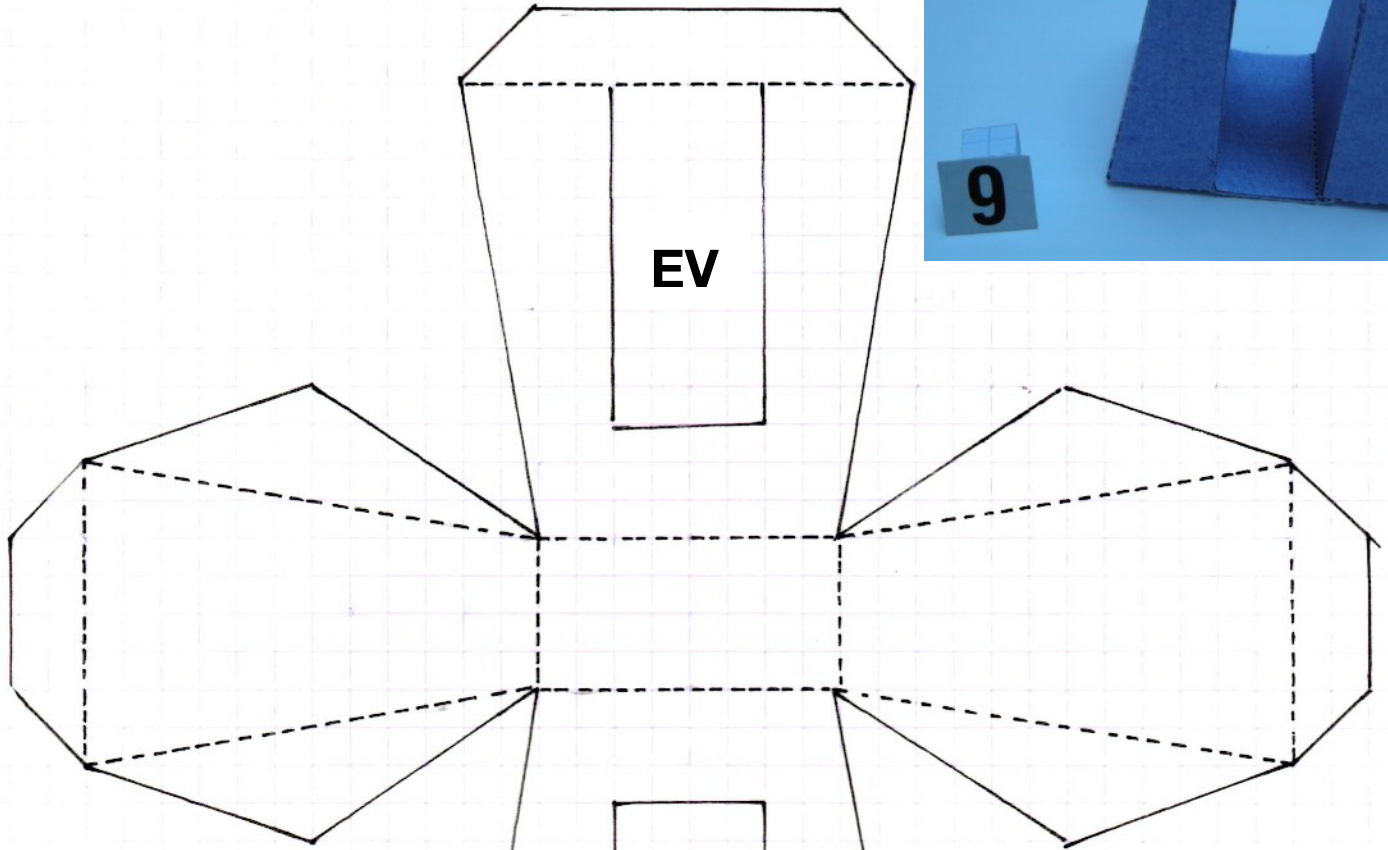
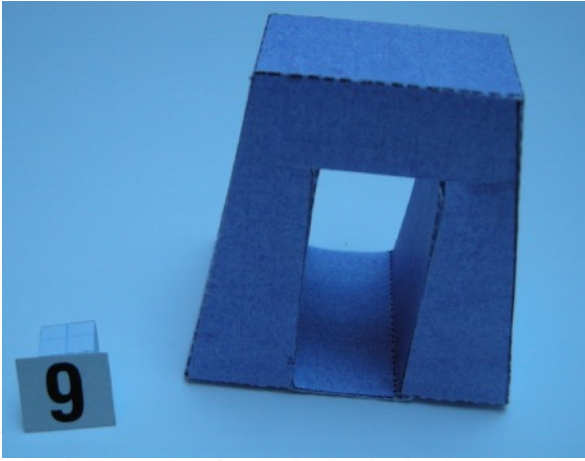

CP

CP

CP

CP

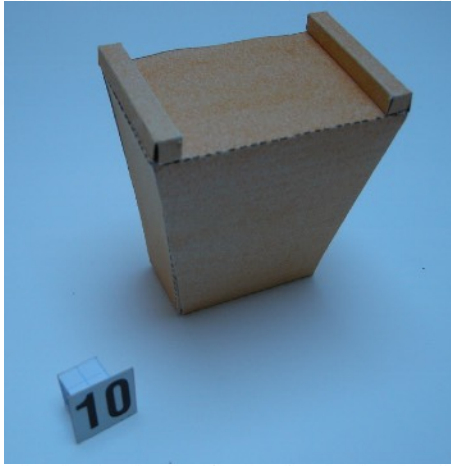

10

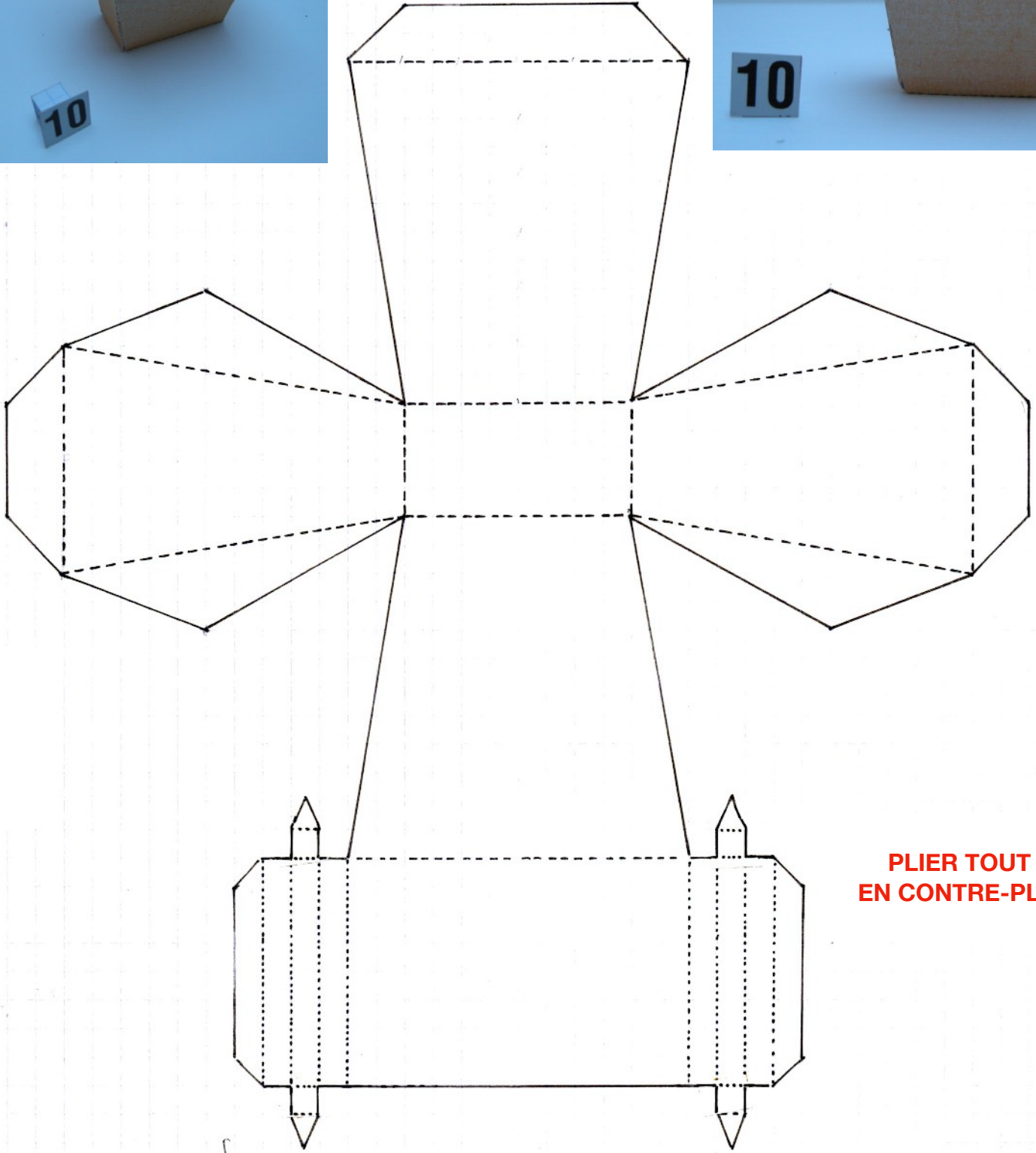
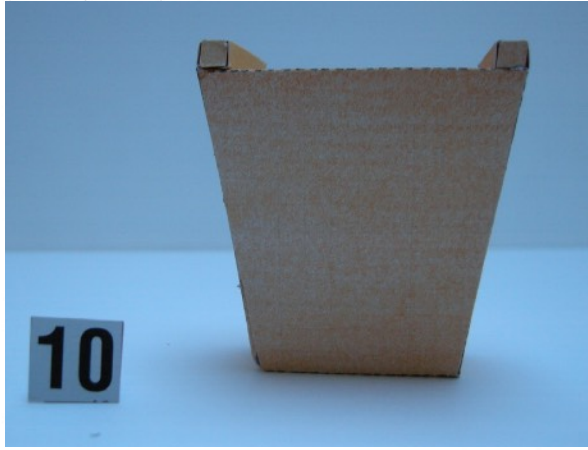

**PLIER TOUT
EN CONTRE-PLIS**

11

11

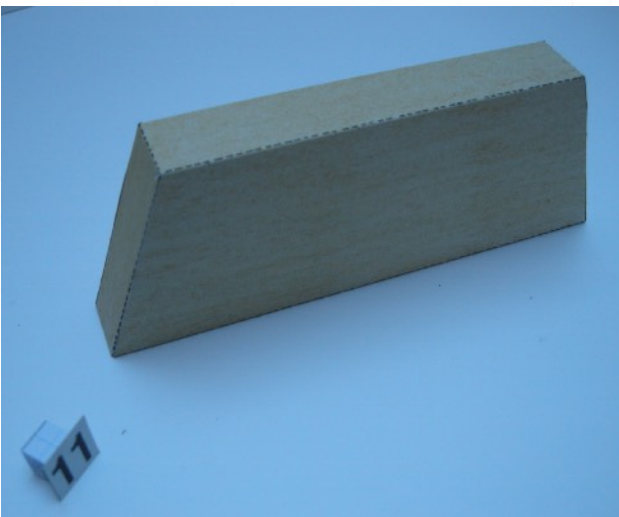

11

